

FlexStation®

DESKING SYSTEM

product offering catalog



Effective November 2014

FlexStation® Worksurfaces	General Information	2
	Finish Options	7
	Basic	8
	Mobile/Peninsula	16
	Transitional	18
FlexStation® Components	Accessories	23
	General Information	24
	Universal Overhead Storage	26
	Universal Tasklights	31
	Venus® Overhead Storage	32
	Venus® Task Lights	34
	Overhead Cabinet	35
	Open Shelf	36
FlexStation® Accessories	Privacy Screens	37
	General Information	40
	Tool Rail and Worksurface Connectors	42
	Paper Management	43
FlexStation® with Power	Center Drawer	45
	General Information	46
	FlexStation® with Power	48
FlexStation® with Shared Leg	Electrical	50
	Shared Leg	51

FlexStation® General Information

Basic Worksurfaces



Basic Worksurfaces (WBW)



Adj. Keyboard Pad Worksurfaces (WAK)



Transitional Worksurfaces (WCT)

Features

Solid core top	•	•	•
Plastic laminate surface	•	•	•
Flat vinyl T-edge	•	•	•
Postformed edge	•	•	•
74P edge	•	•	•
Elliptical postformed edge	•	•	•
Powder-coated legs	•	•	•
Seam-welded tubular steel frame	•	•	•
Chrome plated glides	•	•	•

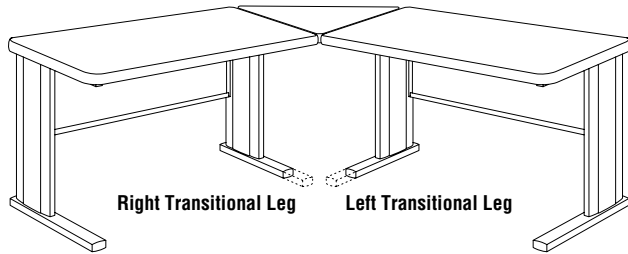

Transitional Leg

Transitional leg bases are 6 inches shorter than standard leg bases for greater leg room and chair clearance when two surfaces are joined. When seated at the worksurface, "right" or "left" refers to the individual worksurface, not the assembled workstation. Cannot be ordered for an individual, free-standing worksurface.

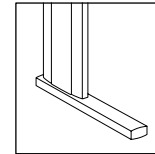

Streamline Leg

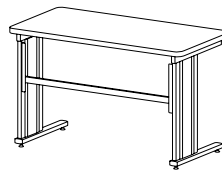

Beam Frame

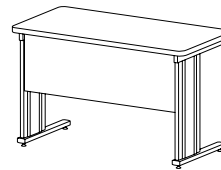

Modesty Panel Frame

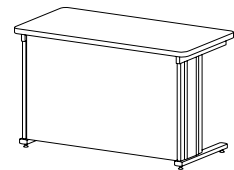

Full Modesty Panel Frame

SPECIFICATIONS

Streamline Worksurface Frames

Heavy-gauge seam-welded powder-coat finished tubular steel. Horizontal tabletop support tube, 16-ga., 1" x 1" steel. Floor support member, 16-ga., 1-1/8' x 1-3/4' belly rectangular steel tube. Top floor support tubes are welded with 2 steel tube vertical leg members. The rear vertical support is 16-ga., 1" x 2" steel tube. The front vertical support is 16-ga., 1" x 2-1/8" bullet oval steel tube. Leg interior provides concealed management of wire from floor to worksurface. Adjustable chrome-plated glides. Powder-coat finish on legs. Casters offered as an option. There are three frame style options. The receptacle clearance beam option (WB) is a 16-ga., 1/2" x 1-1/2" steel tube cross brace, welded to two 14-ga., L-brackets for support. The modesty panel (WM) is 19-ga. steel. It is located 1-1/2" from the rear of the worksurface. The modesty panel is 15.31" on the 29" tables. The full height modesty panel (WF) is 19-ga.

steel. It is located 1-1/2" from the rear of the worksurface. The full modesty panel spans the space between the underside of the worksurface and the floor. It is only available on 29" height desks.

Worksurface Top

1-1/4" thick top, .030" high-pressure plastic laminate top surface with .028" phenolic backing sheet. Available with flat-vinyl T-edge, 74P edge or 180° postformed and elliptical postformed front edge with .042" high pressure laminate and .045 phenolic backing sheet. Side and rear edges of postformed tops are finished with either .024" PVC or .053" high-pressure laminate.

Surface Splice Plates

Die-formed steel splice plates attach to underside of units with screws. Two splice plates are provided with all surfaces. Standard connector plate provided when surfaces are of common height. Worksurface height change connector provided for connecting 29" to 27" surfaces on transitional height worksurfaces.

Specify worksurface height change connector for connecting non-transitional worksurfaces of two different heights.

Adjustable Keyboard Pad Worksurface

Die-formed L-brackets attach to table and keyboard pad with screws. Threaded hand knobs lock keyboard pad in position. Available with flat vinyl T-edge and 74P edge.

Weight Capacity

All FlexStation® tables meet or exceed BIFMA 5.5 Standards.

Horizontal Wire Management Trough

Horizontal wire management trough (WW) is located behind the modesty panel and is constructed of rigid PVC with 1" deep by 1-1/2" high openings for cables.

Base Options

There are two options for the base, standard chrome-plated adjustable glides (NC) or four swivel casters (WC). The caster option comes with two casters with locks and it raises worksurface height 3".

Guest Modesty Panel

The Guest Modesty Panel for P Shaped, Piano, and Square Shoe, peninsula worksurfaces is constructed of 19-ga. steel. It is located 4.5" from the guest side of the peninsula worksurface and is attached using 6, #10-1" screws. It is 9" high and comes in lengths to fit 60" through 84" peninsula tops.

FlexStation® General Information

Basic Worksurfaces

FlexStation® General Information

FlexStation® with Power

SPECIFICATIONS

PowerUp® Power/Data Module

The power/data module is inserted into a rectangular hole in the worksurface. The module has a flip-up cover and is 6-1/4" long x 3" wide x 2-1/2" high. It has one duplex receptacle (110 volts), dual data access and a power cord with a 3-prong plug. The cord is 108" long when used without 10-wire (NP) system and 22" long when used with 10-wire (T6) tables. Connections for phones, modems, printers and networks can be incorporated into the system, but must be ordered separately by the customer through a third party source. Communications wiring is completed in the field by the customer. Each unit ships with a data plate tree which provides holders for common jacks produced by AT&T, Panduit, and others. Contact OEI Customer Service for more information. The single module is located at the rear right, rear left or center position of the worksurface widths 30" through 54". Two modules are available on 60", 66" and 72" wide rectangular surfaces and are located at the rear left and rear right position of the worksurface.

Data Door

The data door (WT) is constructed of rigid PVC .06 wall thickness with a radius of 2-1/2". The door is 8" deep and 4-1/2" high. It attaches to the underside of the table top. The hanging bracket uses the same hole as the modesty panel and can also be used with WB option. Power and data cables are separated from each other by a 24-gauge steel divider that is 2" high by 2-3/4" deep. There is also space allowed for cord management. Available in black only.

Table-To-Table Wireway

The table-to-table wireway trough is a 16-gauge steel trough that attaches to the underside of the adjoining worksurface. The wireway is 3-3/4" deep by 4-1/4" wide. The wireway routes the 10-wire table-to-table connector and data wires between tables. The wire management trough also includes a splice plate that attaches the front of the adjoining tops together to prevent separation.

10-Wire 6-Circuit Pre-Wired Harness

Single sided, rigid 10-wire harness that holds two duplex receptacles (60", 66" and 72" wide tables provide access for up to four duplex receptacles). Harness contains 6 hot wires, 2 neutral wires and 2 ground wires and is commonly referred to

as (6-2-2). The harness has mounting brackets to attach to the underside of the worksurface top with screws. The harness is 2-1/2" wide and the length of the harness varies with the size of the top. Power is obtained by use of the 10-wire Power Infeed Kit. Duplex receptacles located under the worksurface are specified separately.

10-Wire Table-To-Table Connector

10-wire table-to-table connector consists of flexible mesh conduit which provides power connections from adjoining tables. The jumper is 17-3/4" long and is routed through the table-to-table wireway.

10-Wire Power Infeed Kit

The 10-wire infeed kit provides power from fixed, floor, or wall sources to the 10-wire harness. It includes 6' of plastic covered flexible conduit, and 3/4" waterproof 90° connector. Also included are two steel covers which replace the existing plastic vertical wireway.

UL Listed

The FlexStation® with PowerUp® System is listed to applicable UL standards and requirements by Underwriters Laboratories, Inc.

Two of the standards used to evaluate FlexStation® are UL/286 Office Furnishings and UL/723 Standard for Test for Surface Burning Characteristics of Building Materials.

The standard used to evaluate PowerUp® is UL 1363 Relocatable Power Taps.

FlexStation® General Information

FlexStation® with Power

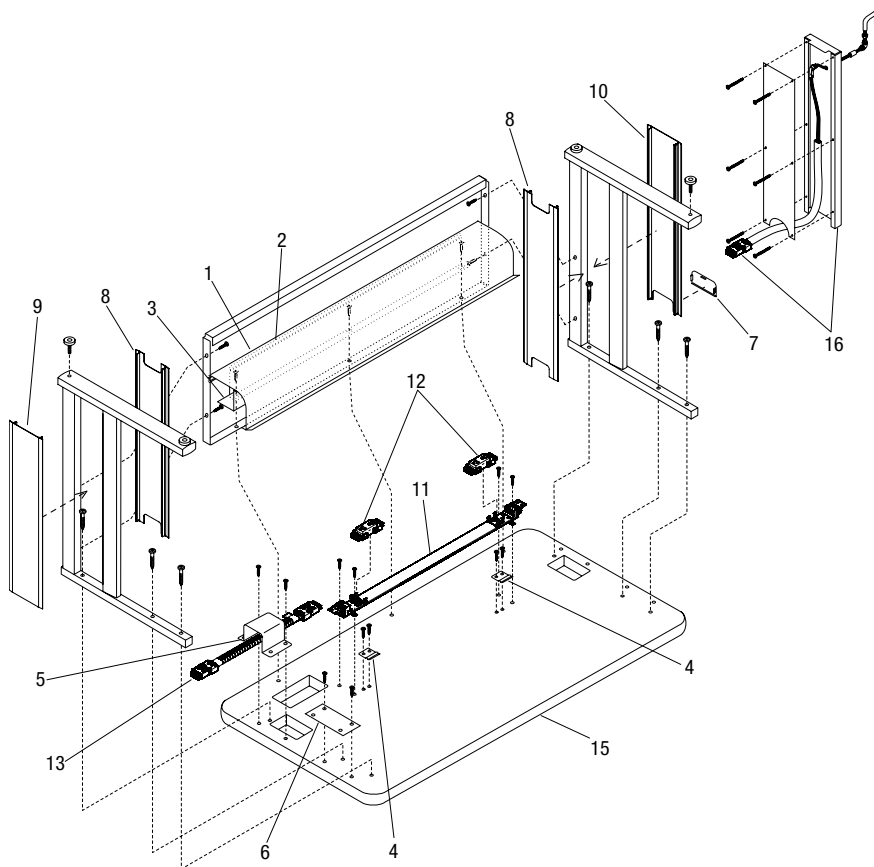
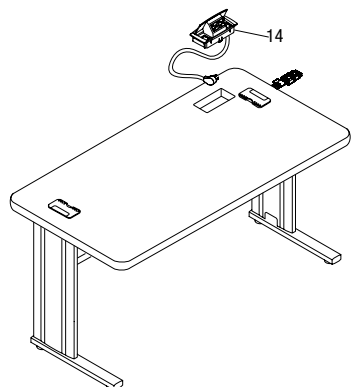

Legend
NT - No Trough
WT - With Trough
NP - No Power
T6 - 10 Wire

PowerUp Parts Listing

Item No.	Item Description	NT	WT	NP	T6
1	Data Door 30"		•		
	Data Door 36"		•		
	Data Door 42"		•		
	Data Door 48"		•		
	Data Door 54"		•		
	Data Door 60"		•		
	Data Door 66"		•		
	Data Door 72"		•		
2	Door Mounting Bracket 30"		•		
	Door Mounting Bracket 36"		•		
	Door Mounting Bracket 42"		•		
	Door Mounting Bracket 48"		•		
	Door Mounting Bracket 54"		•		
	Door Mounting Bracket 60"		•		
	Door Mounting Bracket 66"		•		
	Door Mounting Bracket 72"		•		
3	Steel Power/Data Divider 30"		•		
	Steel Power/Data Divider 36"		•		
	Steel Power/Data Divider 42"		•		
	Steel Power/Data Divider 48"		•		
	Steel Power/Data Divider 54"		•		
	Steel Power/Data Divider 60"		•		
	Steel Power/Data Divider 66"		•		
	Steel Power/Data Divider 72"		•		
4	Clips for Door		•		
5	Table-To-Table Wireway		•		•
6	Splice Plate	•	•	•	•
7	Cap for Vertical Wireway		•		•
8	Vertical Wireway - Inner	•	•	•	•
9	Vertical Wireway - Outer, End-Of-Run	•			
10	Vertical Wireway - Outer		•		•
11	10-Wire Harness 30"				•
	10-Wire Harness 36"				•
	10-Wire Harness 42"				•
	10-Wire Harness 48"				•
	10-Wire Harness 54"				•
	10-Wire Harness 60"				•
	10-Wire Harness 66"				•
	10-Wire Harness 72"				•
12	Duplex Receptacles (optional - must be ordered separately)				
13	10-Wire Table-To-Table Connector (optional - must be ordered separately)				
14	Power Data Module				
15	WorkZone Top only with cut-outs				
16	Steel Infeed 27" Cover Plate Assembly				
	Steel Infeed 29" Cover Plate Assembly				
	Steel Infeed 42" Cover Plate Assembly				
	(optional - must be ordered separately)				

FlexStation® General Information

FlexStation® Shared Leg



Starter Unit



Adder Unit



Finisher Unit

Starter Unit - Each shared leg workplace requires a starter unit to be placed at one end of the table string. The starter unit is comprised of a worksurface, modesty panel, standard leg and transitional leg. Only one starter unit is required in a single table string.

Adder Unit - When three or more tables make up a table string adder units are used to make up the middle portion of the table string. The adder unit is comprised of a worksurface, modesty panel and transitional leg.

Finisher Unit - The final table specified in a table string is the finisher unit. This unit is comprised of a worksurface, modesty panel and a standard leg.

All three units are joined together by the transitional legs, which are centered between the two worksurfaces and attach accordingly. When specifying the shared leg option, it is possible to specify tables with the LapTop Garage® in the same table string as other tables without LapTop Garages.

**FlexStation®, and FlexStation®
with Power Worksurfaces/
Components/Overhead Storage**
Paint Color

Black	BL
Blue Grey	GR
Champagne Metallic	CM
Cool Grey	CG
Espresso Metallic	EX
Light Tone	LG
Misty Brown	MY
Sand	SA
Starlight Silver	SX
Warm Grey	WG

Insert Color

Black	IBL
Blue Grey	IGR
Cool Grey	ICG
Light Tone	ILG
Misty Brown	IMY
Sand	ISA
Warm Grey	IWG

Edge Color (74P)

Biltmore Cherry*	EBT
Black	EBL
Blue Grey	EGR
Brighton Walnut	EBW
Castle Oak	ECO
Cherry Storm	ECX
Cocobala	ECC
Cool Grey	ECG
Flannel	EFN
Frosty White	EFW
Kensington Maple	EKM
Light Tone	ELG
Misty Brown	EMY
Monticello Maple	EMT
River Cherry	ERY
Sand	ESA
Warm Grey	EWG
Wet Sand	EWS
Windsor Mahogany	EWY

Edge Color (54B)

Black	EBL
Blue Grey	EGR
Flannel	EFN
Frosty White	EFW
Light Tone	ELG
Sand	ESA
Warm Grey	EWG
Wet Sand	EWS

Grommet Color

Black	GBL
Blue Grey	GGR
Cool Grey	GCG
Light Tone	GLG
Misty Brown	GMY
Sand	GSA
Warm Grey	GWG

Laminate Upper Door Color

Beige Nebula	LBA
Biltmore Cherry	LBT
Black	LBK
Blue Agave	LBE
Brighton Walnut	LBW
Canyon Zephyr	LCA
Castle Oak	LCO
Cherry Storm	LCX
Cloud Nebula	LCN
Cloud Zephyr	LCL
Cocobala	LCC
Coffee Bean	LCB
Desert Zephyr	LDZ
Eggplant	LET
Frosty White	LFW
Graphite Nebula	LGN
Grey	LGE
Grey Moss	LGS
Hollyberry	LHY
Kensington Maple	LKM
Kiwi	LKI
Loden Zephyr	LLZ
Misted Zephyr	LMR
Monticello Maple	LMT
Morro Zephyr	LMY
Nickel Evolv	LNV
North Sea	LNA
Pearl Bisque	LPB
Pearl Dust	LPD
Pearl Silver	LPS
Pomegranate	LPO
River Cherry	LRY
Satin Oxide	LSX
Satin Stainless	LSS
Shadow Zephyr	LSR
Silicon Evolv	LSV
Spiced Zephyr	LSZ
Sprout	LZP
Sterling Ash	LAZ
Tangerine	LTR
Titanium Evolv	LTV
Tungsten Evolv	LTE
White Nebula	LWL
White Sand	LWN
Windsor Mahogany	LWY

Universal Overhead Paint Color

Black	BL
Blue Grey	GR
Champagne Metallic	CM
Espresso Metallic	EX
Cool Grey	CG
Light Tone	LG
Misty Brown	MY
Sand	SA
Starlight Silver	SX
Warm Grey	WG

**Venus® Laminate Door
Edge Color**

Black	EBL
Blue Grey	EGR
Light Tone	ELG
Sand	ESA
Warm Grey	EWG

**Venus® Overhead Cabinet
Paint Color**

Black	BL
Blue Grey	GR
Bronze Metallic	ZM
Cayenne	CY
Champagne Metallic	CM
Chocolate	CT
Cool Grey	CG
Cottonwood	CO
Espresso Metallic	EX
Flannel	FN
Light Tone	LG
Mardi Gras	MG
Misty Brown	MY
Nemo	NE
Nordic	ND
Purple Haze	PH
Rubber Ducky	RK
Sand	SA
Splash	SH
Starlight Silver	SX
Surf's Up	SP
Ultra Blue	UB
Warm Grey	WG
Wet Sand	WS
Zesty Lime	ZL

Venus® Upper Door Solid Color

Black	UBL
Blue Grey	UGR
Cool Grey	UCG
Light Tone	ULG
Misty Brown	UMY
Sand	USA
Translucent	UTR
Warm Grey	UWG

Accessory Color

Black	MBL
Blue Grey	MGR
Cool Grey	MCG
Light Tone	MLG
Misty Brown	MMY
Sand	MSA
Warm Grey	MWG

Data door and table-to-table wireway connector is always black.

FlexStation® Worksurfaces

Basic

D x W	MODEL NUMBER													
	Basic Model	Edge Style	Hgt.	WWay	Frame Style	Trans. Legs	Worksurface Grommet	Paint Color	Insert Color	Base	Lam. Color	Edge Color	Grommet Color	
24 x 30"	WBW2430	<input type="checkbox"/> <input type="checkbox"/>	<input type="checkbox"/>	<input type="checkbox"/>	<input type="checkbox"/>	<input type="checkbox"/>	<input type="checkbox"/> <input type="checkbox"/>	<input type="checkbox"/>	<input type="checkbox"/> <input type="checkbox"/>	<input type="checkbox"/>	<input type="checkbox"/> <input type="checkbox"/>	<input type="checkbox"/> <input type="checkbox"/>	<input type="checkbox"/> <input type="checkbox"/>	
24 x 36"	WBW2436	<input type="checkbox"/> <input type="checkbox"/>	<input type="checkbox"/>	<input type="checkbox"/>	<input type="checkbox"/>	<input type="checkbox"/>	<input type="checkbox"/> <input type="checkbox"/>	<input type="checkbox"/>	<input type="checkbox"/> <input type="checkbox"/>	<input type="checkbox"/>	<input type="checkbox"/> <input type="checkbox"/>	<input type="checkbox"/> <input type="checkbox"/>	<input type="checkbox"/> <input type="checkbox"/>	
24 x 42"	WBW2442	<input type="checkbox"/> <input type="checkbox"/>	<input type="checkbox"/>	<input type="checkbox"/>	<input type="checkbox"/>	<input type="checkbox"/>	<input type="checkbox"/> <input type="checkbox"/>	<input type="checkbox"/>	<input type="checkbox"/> <input type="checkbox"/>	<input type="checkbox"/>	<input type="checkbox"/> <input type="checkbox"/>	<input type="checkbox"/> <input type="checkbox"/>	<input type="checkbox"/> <input type="checkbox"/>	
24 x 48"	WBW2448	<input type="checkbox"/> <input type="checkbox"/>	<input type="checkbox"/>	<input type="checkbox"/>	<input type="checkbox"/>	<input type="checkbox"/>	<input type="checkbox"/> <input type="checkbox"/>	<input type="checkbox"/>	<input type="checkbox"/> <input type="checkbox"/>	<input type="checkbox"/>	<input type="checkbox"/> <input type="checkbox"/>	<input type="checkbox"/> <input type="checkbox"/>	<input type="checkbox"/> <input type="checkbox"/>	
24 x 54"	WBW2454	<input type="checkbox"/> <input type="checkbox"/>	<input type="checkbox"/>	<input type="checkbox"/>	<input type="checkbox"/>	<input type="checkbox"/>	<input type="checkbox"/> <input type="checkbox"/>	<input type="checkbox"/>	<input type="checkbox"/> <input type="checkbox"/>	<input type="checkbox"/>	<input type="checkbox"/> <input type="checkbox"/>	<input type="checkbox"/> <input type="checkbox"/>	<input type="checkbox"/> <input type="checkbox"/>	
24 x 60"	WBW2460	<input type="checkbox"/> <input type="checkbox"/>	<input type="checkbox"/>	<input type="checkbox"/>	<input type="checkbox"/>	<input type="checkbox"/>	<input type="checkbox"/> <input type="checkbox"/>	<input type="checkbox"/>	<input type="checkbox"/> <input type="checkbox"/>	<input type="checkbox"/>	<input type="checkbox"/> <input type="checkbox"/>	<input type="checkbox"/> <input type="checkbox"/>	<input type="checkbox"/> <input type="checkbox"/>	
24 x 66"	WBW2466	<input type="checkbox"/> <input type="checkbox"/>	<input type="checkbox"/>	<input type="checkbox"/>	<input type="checkbox"/>	<input type="checkbox"/>	<input type="checkbox"/> <input type="checkbox"/>	<input type="checkbox"/>	<input type="checkbox"/> <input type="checkbox"/>	<input type="checkbox"/>	<input type="checkbox"/> <input type="checkbox"/>	<input type="checkbox"/> <input type="checkbox"/>	<input type="checkbox"/> <input type="checkbox"/>	
24 x 72"	WBW2472	<input type="checkbox"/> <input type="checkbox"/>	<input type="checkbox"/>	<input type="checkbox"/>	<input type="checkbox"/>	<input type="checkbox"/>	<input type="checkbox"/> <input type="checkbox"/>	<input type="checkbox"/>	<input type="checkbox"/> <input type="checkbox"/>	<input type="checkbox"/>	<input type="checkbox"/> <input type="checkbox"/>	<input type="checkbox"/> <input type="checkbox"/>	<input type="checkbox"/> <input type="checkbox"/>	
30 x 30"	WBW3030	<input type="checkbox"/> <input type="checkbox"/>	<input type="checkbox"/>	<input type="checkbox"/>	<input type="checkbox"/>	<input type="checkbox"/>	<input type="checkbox"/> <input type="checkbox"/>	<input type="checkbox"/>	<input type="checkbox"/> <input type="checkbox"/>	<input type="checkbox"/>	<input type="checkbox"/> <input type="checkbox"/>	<input type="checkbox"/> <input type="checkbox"/>	<input type="checkbox"/> <input type="checkbox"/>	
30 x 36"	WBW3036	<input type="checkbox"/> <input type="checkbox"/>	<input type="checkbox"/>	<input type="checkbox"/>	<input type="checkbox"/>	<input type="checkbox"/>	<input type="checkbox"/> <input type="checkbox"/>	<input type="checkbox"/>	<input type="checkbox"/> <input type="checkbox"/>	<input type="checkbox"/>	<input type="checkbox"/> <input type="checkbox"/>	<input type="checkbox"/> <input type="checkbox"/>	<input type="checkbox"/> <input type="checkbox"/>	
30 x 42"	WBW3042	<input type="checkbox"/> <input type="checkbox"/>	<input type="checkbox"/>	<input type="checkbox"/>	<input type="checkbox"/>	<input type="checkbox"/>	<input type="checkbox"/> <input type="checkbox"/>	<input type="checkbox"/>	<input type="checkbox"/> <input type="checkbox"/>	<input type="checkbox"/>	<input type="checkbox"/> <input type="checkbox"/>	<input type="checkbox"/> <input type="checkbox"/>	<input type="checkbox"/> <input type="checkbox"/>	
30 x 48"	WBW3048	<input type="checkbox"/> <input type="checkbox"/>	<input type="checkbox"/>	<input type="checkbox"/>	<input type="checkbox"/>	<input type="checkbox"/>	<input type="checkbox"/> <input type="checkbox"/>	<input type="checkbox"/>	<input type="checkbox"/> <input type="checkbox"/>	<input type="checkbox"/>	<input type="checkbox"/> <input type="checkbox"/>	<input type="checkbox"/> <input type="checkbox"/>	<input type="checkbox"/> <input type="checkbox"/>	
30 x 54"	WBW3054	<input type="checkbox"/> <input type="checkbox"/>	<input type="checkbox"/>	<input type="checkbox"/>	<input type="checkbox"/>	<input type="checkbox"/>	<input type="checkbox"/> <input type="checkbox"/>	<input type="checkbox"/>	<input type="checkbox"/> <input type="checkbox"/>	<input type="checkbox"/>	<input type="checkbox"/> <input type="checkbox"/>	<input type="checkbox"/> <input type="checkbox"/>	<input type="checkbox"/> <input type="checkbox"/>	
30 x 60"	WBW3060	<input type="checkbox"/> <input type="checkbox"/>	<input type="checkbox"/>	<input type="checkbox"/>	<input type="checkbox"/>	<input type="checkbox"/>	<input type="checkbox"/> <input type="checkbox"/>	<input type="checkbox"/>	<input type="checkbox"/> <input type="checkbox"/>	<input type="checkbox"/>	<input type="checkbox"/> <input type="checkbox"/>	<input type="checkbox"/> <input type="checkbox"/>	<input type="checkbox"/> <input type="checkbox"/>	
30 x 66"	WBW3066	<input type="checkbox"/> <input type="checkbox"/>	<input type="checkbox"/>	<input type="checkbox"/>	<input type="checkbox"/>	<input type="checkbox"/>	<input type="checkbox"/> <input type="checkbox"/>	<input type="checkbox"/>	<input type="checkbox"/> <input type="checkbox"/>	<input type="checkbox"/>	<input type="checkbox"/> <input type="checkbox"/>	<input type="checkbox"/> <input type="checkbox"/>	<input type="checkbox"/> <input type="checkbox"/>	
30 x 72"	WBW3072	<input type="checkbox"/> <input type="checkbox"/>	<input type="checkbox"/>	<input type="checkbox"/>	<input type="checkbox"/>	<input type="checkbox"/>	<input type="checkbox"/> <input type="checkbox"/>	<input type="checkbox"/>	<input type="checkbox"/> <input type="checkbox"/>	<input type="checkbox"/>	<input type="checkbox"/> <input type="checkbox"/>	<input type="checkbox"/> <input type="checkbox"/>	<input type="checkbox"/> <input type="checkbox"/>	
		A	B	C	D	E	F	G	H	I	J	K	L	M

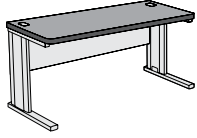

WBWFO

Basic Worksurface

- Adjustable glides or casters
- 66" and 72" wide overhead are not available on FlexStation® frames with beams

HOW TO ORDER

Indicate the following information on order form:

- Quantity of each item.
- Model number, including options. See "How To Build a Model Number".
- Any special service required.

Note: • The indicates that a choice is required.
 • The absence of the indicates that no choice is required.
 • Alpha-numeric characters in place of indicates that no other alternatives are available.

HOW TO BUILD A MODEL NUMBER

A Select basic model.

B Select edge style.

BN - Flat vinyl T-edge
74P - 74P edge

C Select height.

7 - 27" high
9 - 29" high

D Select horizontal wireway.

NW - No horizontal wireway
WW - Wireway

E Select frame style.

WB - w/ Beam
WM - w/ Modesty panel
WF - w/ Full modesty panel
 w/ Full modesty panel (available on 29" high only)

F Select location and type of leg.

TS - Standard legs
TL - Transition leg (left)
TR - Transition leg (right)
TB - Transition leg (both)

Note: If ordering Basic Worksurface as a freestanding unit, or if only one side connects to a transitional worksurface, the "TB" option for both transitional legs is not available.

G Select grommet option.

Grommets are required for overhead cabinet.
OGN - No worksurface grommet
OGY - Yes worksurface grommet
 Grommets can be used for wire pass-through.

H Select paint color.

Refer to Finish Options on page 7.

I Select insert color.

Refer to Finish Options on page 7. Insert color also includes horizontal wireway (WW) if selected.

J Select base option.

NC - With glides (standard)
WC - With casters

K Select laminate surface.

Refer to Finish Options on page 7.

L Select edge color.

Refer to Finish Options on page 7. Edge color offerings are based on edge style selections.

M Select grommet color.

Refer to Finish Options on page 7.

FlexStation® Worksurfaces

Basic

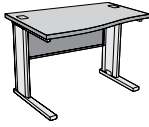
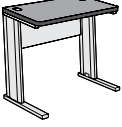
	D x W x D	MODEL NUMBER												
		Basic Model	Edge Style	Height	WWay	Frame Style	Trans. Legs	Wrksrf. Grom.	Paint Color	Insert Color	Base	Lam. Color	Edge Color	Grom. Color
 <p>WRCFO Curvilinear Worksurface</p> <ul style="list-style-type: none"> • Joins 24" deep worksurface to 30" deep worksurface • Available in 27" and 29" height only • Adjustable glides or casters 	24 x 42 x 30"	WRC244230	<input type="checkbox"/>	<input type="checkbox"/>	<input type="checkbox"/>	<input type="checkbox"/>	<input type="checkbox"/>	<input type="checkbox"/>	<input type="checkbox"/>	<input type="checkbox"/>	<input type="checkbox"/>	<input type="checkbox"/>	<input type="checkbox"/>	<input type="checkbox"/>
	24 x 48 x 30"	WRC244830	<input type="checkbox"/>	<input type="checkbox"/>	<input type="checkbox"/>	<input type="checkbox"/>	<input type="checkbox"/>	<input type="checkbox"/>	<input type="checkbox"/>	<input type="checkbox"/>	<input type="checkbox"/>	<input type="checkbox"/>	<input type="checkbox"/>	<input type="checkbox"/>
	24 x 54 x 30"	WRC245430	<input type="checkbox"/>	<input type="checkbox"/>	<input type="checkbox"/>	<input type="checkbox"/>	<input type="checkbox"/>	<input type="checkbox"/>	<input type="checkbox"/>	<input type="checkbox"/>	<input type="checkbox"/>	<input type="checkbox"/>	<input type="checkbox"/>	<input type="checkbox"/>
	24 x 60 x 30"	WRC246030	<input type="checkbox"/>	<input type="checkbox"/>	<input type="checkbox"/>	<input type="checkbox"/>	<input type="checkbox"/>	<input type="checkbox"/>	<input type="checkbox"/>	<input type="checkbox"/>	<input type="checkbox"/>	<input type="checkbox"/>	<input type="checkbox"/>	<input type="checkbox"/>
	24 x 66 x 30"	WRC246630	<input type="checkbox"/>	<input type="checkbox"/>	<input type="checkbox"/>	<input type="checkbox"/>	<input type="checkbox"/>	<input type="checkbox"/>	<input type="checkbox"/>	<input type="checkbox"/>	<input type="checkbox"/>	<input type="checkbox"/>	<input type="checkbox"/>	<input type="checkbox"/>
	24 x 72 x 30"	WRC247230	<input type="checkbox"/>	<input type="checkbox"/>	<input type="checkbox"/>	<input type="checkbox"/>	<input type="checkbox"/>	<input type="checkbox"/>	<input type="checkbox"/>	<input type="checkbox"/>	<input type="checkbox"/>	<input type="checkbox"/>	<input type="checkbox"/>	<input type="checkbox"/>
	30 x 42 x 24"	WRC304224	<input type="checkbox"/>	<input type="checkbox"/>	<input type="checkbox"/>	<input type="checkbox"/>	<input type="checkbox"/>	<input type="checkbox"/>	<input type="checkbox"/>	<input type="checkbox"/>	<input type="checkbox"/>	<input type="checkbox"/>	<input type="checkbox"/>	<input type="checkbox"/>
	30 x 48 x 24"	WRC304824	<input type="checkbox"/>	<input type="checkbox"/>	<input type="checkbox"/>	<input type="checkbox"/>	<input type="checkbox"/>	<input type="checkbox"/>	<input type="checkbox"/>	<input type="checkbox"/>	<input type="checkbox"/>	<input type="checkbox"/>	<input type="checkbox"/>	<input type="checkbox"/>
	30 x 54 x 24"	WRC305424	<input type="checkbox"/>	<input type="checkbox"/>	<input type="checkbox"/>	<input type="checkbox"/>	<input type="checkbox"/>	<input type="checkbox"/>	<input type="checkbox"/>	<input type="checkbox"/>	<input type="checkbox"/>	<input type="checkbox"/>	<input type="checkbox"/>	<input type="checkbox"/>
	30 x 60 x 24"	WRC306024	<input type="checkbox"/>	<input type="checkbox"/>	<input type="checkbox"/>	<input type="checkbox"/>	<input type="checkbox"/>	<input type="checkbox"/>	<input type="checkbox"/>	<input type="checkbox"/>	<input type="checkbox"/>	<input type="checkbox"/>	<input type="checkbox"/>	<input type="checkbox"/>
30 x 66 x 24"	WRC306624	<input type="checkbox"/>	<input type="checkbox"/>	<input type="checkbox"/>	<input type="checkbox"/>	<input type="checkbox"/>	<input type="checkbox"/>	<input type="checkbox"/>	<input type="checkbox"/>	<input type="checkbox"/>	<input type="checkbox"/>	<input type="checkbox"/>	<input type="checkbox"/>	
30 x 72 x 24"	WRC307224	<input type="checkbox"/>	<input type="checkbox"/>	<input type="checkbox"/>	<input type="checkbox"/>	<input type="checkbox"/>	<input type="checkbox"/>	<input type="checkbox"/>	<input type="checkbox"/>	<input type="checkbox"/>	<input type="checkbox"/>	<input type="checkbox"/>	<input type="checkbox"/>	
 <p>WCSFO Stand-up Worksurface</p> <ul style="list-style-type: none"> • Available in 42" height only • Adjustable glides • Overheads cannot be mounted on any stand up worksurface 	30 x 36"	WSU3036	<input type="checkbox"/>	2	<input type="checkbox"/>	<input type="checkbox"/>	TS	<input type="checkbox"/>	<input type="checkbox"/>	<input type="checkbox"/>	NC	<input type="checkbox"/>	<input type="checkbox"/>	<input type="checkbox"/>

A

B

C

D

E

F

G

H

I

J

K

L

M

HOW TO ORDER

Indicate the following information on order form:

- Quantity of each item.
- Model number, including options. See "How To Build a Model Number".
- Any special service required.

Note: • The indicates that a choice is required.

- The absence of the indicates that no choice is required.
- Alpha-numeric characters in place of indicates that no other alternatives are available.

HOW TO BUILD A MODEL NUMBER

A Select basic model.

B Select edge style.

BN - Flat vinyl T-edge
74P - 74P edge

C Select height.

7 - 27" high
9 - 29" high
2 - 42" high

42" height only available on Stand-up worksurface.

D Select horizontal wireway.

NW - No horizontal wireway
WW - Wireway

E Select frame style.

WB - w/ Beam

WM - w/ Modesty panel

WF - w/ Full modesty panel

w/ Full modesty panel (available on 29" high only)

F Select location and type of leg.

TS - Standard legs

TL - Transition leg (left)

TR - Transition leg (right)

TB - Transition leg (both)

Note: If ordering Basic Worksurface as a freestanding unit, or if only one side connects to a transitional worksurface, the "TB" option for both transitional legs is not available.

G Select grommet option.

Grommets are required for overhead cabinet.

OGN - No worksurface grommet

OGY - Yes worksurface grommet

Grommets can be used for wire pass-through.

H Select paint color.

Refer to Finish Options on page 7.

I Select insert color.

Refer to Finish Options on page 7. Insert color also includes horizontal wireway (WW) if selected.

J Select base option.

NC - With glides (standard)

WC - With casters

K Select laminate surface.

Refer to Finish Options on page 7.

L Select edge color.

Refer to Finish Options on page 7. Edge color offerings are based on edge style selections.

M Select grommet color.

Refer to Finish Options on page 7.

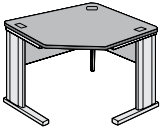
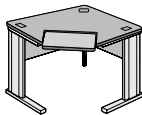
	D x W-LEFT x W-RIGHT x D	MODEL NUMBER												
		Basic Model	Edge Style	Hgt.	WWay	Frame Style	Trans. Legs	Wrksrf. Grom.	Paint Color	Insert Color	Lam. Color	Edge Color	Grom. Color	
 <p>WCSFO Stand Alone Corner Worksurface</p> <ul style="list-style-type: none"> Adjustable glides Corner support leg is 7/8" sq. tubular steel Front edge dimension is 17" on 24 x 36" and 30 x 42"; 25-1/2" on 24 x 42" and 30 x 48"; 34" on 24 x 48" Not available with both (TB) transitional legs 	24 x 36 x 36 x 24"	WCS2436	<input type="checkbox"/> <input type="checkbox"/> <input type="checkbox"/>	<input type="checkbox"/>	<input type="checkbox"/> <input type="checkbox"/>	<input type="checkbox"/> <input type="checkbox"/>	<input type="checkbox"/> <input type="checkbox"/>	<input type="checkbox"/> <input type="checkbox"/>	<input type="checkbox"/> <input type="checkbox"/>	<input type="checkbox"/> <input type="checkbox"/>	<input type="checkbox"/> <input type="checkbox"/>	<input type="checkbox"/> <input type="checkbox"/>	<input type="checkbox"/> <input type="checkbox"/>	
	24 x 42 x 42 x 24"	WCS2442	<input type="checkbox"/> <input type="checkbox"/> <input type="checkbox"/>	<input type="checkbox"/>	<input type="checkbox"/> <input type="checkbox"/>	<input type="checkbox"/> <input type="checkbox"/>	<input type="checkbox"/> <input type="checkbox"/>	<input type="checkbox"/> <input type="checkbox"/>	<input type="checkbox"/> <input type="checkbox"/>	<input type="checkbox"/> <input type="checkbox"/>	<input type="checkbox"/> <input type="checkbox"/>	<input type="checkbox"/> <input type="checkbox"/>	<input type="checkbox"/> <input type="checkbox"/>	
	24 x 48 x 48 x 24"	WCS2448	<input type="checkbox"/> <input type="checkbox"/> <input type="checkbox"/>	<input type="checkbox"/>	<input type="checkbox"/> <input type="checkbox"/>	<input type="checkbox"/> <input type="checkbox"/>	<input type="checkbox"/> <input type="checkbox"/>	<input type="checkbox"/> <input type="checkbox"/>	<input type="checkbox"/> <input type="checkbox"/>	<input type="checkbox"/> <input type="checkbox"/>	<input type="checkbox"/> <input type="checkbox"/>	<input type="checkbox"/> <input type="checkbox"/>	<input type="checkbox"/> <input type="checkbox"/>	
	30 x 42 x 42 x 30"	WCS3042	<input type="checkbox"/> <input type="checkbox"/> <input type="checkbox"/>	<input type="checkbox"/>	<input type="checkbox"/> <input type="checkbox"/>	<input type="checkbox"/> <input type="checkbox"/>	<input type="checkbox"/> <input type="checkbox"/>	<input type="checkbox"/> <input type="checkbox"/>	<input type="checkbox"/> <input type="checkbox"/>	<input type="checkbox"/> <input type="checkbox"/>	<input type="checkbox"/> <input type="checkbox"/>	<input type="checkbox"/> <input type="checkbox"/>	<input type="checkbox"/> <input type="checkbox"/>	
	30 x 48 x 48 x 30"	WCS3048	<input type="checkbox"/> <input type="checkbox"/> <input type="checkbox"/>	<input type="checkbox"/>	<input type="checkbox"/> <input type="checkbox"/>	<input type="checkbox"/> <input type="checkbox"/>	<input type="checkbox"/> <input type="checkbox"/>	<input type="checkbox"/> <input type="checkbox"/>	<input type="checkbox"/> <input type="checkbox"/>	<input type="checkbox"/> <input type="checkbox"/>	<input type="checkbox"/> <input type="checkbox"/>	<input type="checkbox"/> <input type="checkbox"/>	<input type="checkbox"/> <input type="checkbox"/>	
 <p>WAKFO Stand Alone Corner Worksurface with Keyboard</p> <ul style="list-style-type: none"> Adjustable glides Keyboard pad: 10" x 24"; 3" height adjustments: 1" forward extension adjustment: 15° maximum downward tilt Corner support leg is 7/8" square tubular steel Not available with both (TB) transitional legs 	24 x 42 x 42 x 24"	WCSK2442	<input type="checkbox"/> <input type="checkbox"/> <input type="checkbox"/>	<input type="checkbox"/>	<input type="checkbox"/> <input type="checkbox"/>	<input type="checkbox"/> <input type="checkbox"/>	<input type="checkbox"/> <input type="checkbox"/>	<input type="checkbox"/> <input type="checkbox"/>	<input type="checkbox"/> <input type="checkbox"/>	<input type="checkbox"/> <input type="checkbox"/>	<input type="checkbox"/> <input type="checkbox"/>	<input type="checkbox"/> <input type="checkbox"/>		
	24 x 48 x 48 x 24"	WCSK2448	<input type="checkbox"/> <input type="checkbox"/> <input type="checkbox"/>	<input type="checkbox"/>	<input type="checkbox"/> <input type="checkbox"/>	<input type="checkbox"/> <input type="checkbox"/>	<input type="checkbox"/> <input type="checkbox"/>	<input type="checkbox"/> <input type="checkbox"/>	<input type="checkbox"/> <input type="checkbox"/>	<input type="checkbox"/> <input type="checkbox"/>	<input type="checkbox"/> <input type="checkbox"/>	<input type="checkbox"/> <input type="checkbox"/>		
	30 x 48 x 48 x 30"	WCSK3048	<input type="checkbox"/> <input type="checkbox"/> <input type="checkbox"/>	<input type="checkbox"/>	<input type="checkbox"/> <input type="checkbox"/>	<input type="checkbox"/> <input type="checkbox"/>	<input type="checkbox"/> <input type="checkbox"/>	<input type="checkbox"/> <input type="checkbox"/>	<input type="checkbox"/> <input type="checkbox"/>	<input type="checkbox"/> <input type="checkbox"/>	<input type="checkbox"/> <input type="checkbox"/>	<input type="checkbox"/> <input type="checkbox"/>		
			A	B	C	D	E	F	G	H	I	J	K	L

HOW TO ORDER

Indicate the following information on order form:

- Quantity of each item.
- Model number, including options. See "How To Build a Model Number".
- Any special service required.

Note: • The indicates that a choice is required.
 • The absence of the indicates that no choice is required.
 • Alpha-numeric characters in place of indicates that no other alternatives are available.

HOW TO BUILD A MODEL NUMBER

- A** Select basic model.
- B** Select edge style.
BN - Flat vinyl T-edge
74P - 74P edge
- C** Select height.
7 - 27" high
9 - 29" high
- D** Select horizontal wireway.
NW - No horizontal wireway
WW - Wireway
- E** Select frame style.
WB - w/ Beam
WM - w/ Modesty panel
WF - w/ Full modesty panel
 w/ Full modesty panel (available on 29" high only)
- F** Select location and type of leg.
TS - Standard legs
TL - Transition leg (left)
TR - Transition leg (right)
- G** Select grommet option.
 Grommets are required for overhead cabinet.
OGN - No worksurface grommet
OGY - Yes worksurface grommet
 Grommets can be used for wire pass-through.
- H** Select paint color.
 Refer to Finish Options on page 7.
- I** Select insert color.
 Refer to Finish Options on page 7.
 Insert color also includes horizontal wireway (WW) if selected.
- J** Select laminate surface.
 Refer to Finish Options on page 7.
- K** Select edge color.
 Refer to Finish Options on page 7.
 Edge color offerings are based on edge style selections.
- L** Select grommet color.
 Refer to Finish Options on page 7.

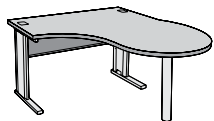
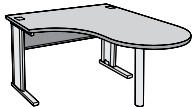
	D x W x L	MODEL NUMBER													
		Basic Model	Edge Style	Dir.	Hgt.	WWay	Frame Style	Trans. Legs	Wrksrf. Grom.	Paint Color	Insert Color	Lam. Color	Edge Color	Grom. Color	
 <p>WZWFO</p> <p>"P" Shaped Peninsula Worksurface (Right Shown)</p> <ul style="list-style-type: none"> • Long surface is supported by 3" diameter metal support leg with adjustable glide • Connects to either 24" or 30" worksurface • Adjustable glides • Available with 29" height only 	24 x 48 x 60"	WZPT244860	<input type="checkbox"/>	<input type="checkbox"/>	9	<input type="checkbox"/>	<input type="checkbox"/>	<input type="checkbox"/>	<input type="checkbox"/>	<input type="checkbox"/>	<input type="checkbox"/>	<input type="checkbox"/>	<input type="checkbox"/>	<input type="checkbox"/>	
	24 x 48 x 66"	WZPT244866	<input type="checkbox"/>	<input type="checkbox"/>	9	<input type="checkbox"/>	<input type="checkbox"/>	<input type="checkbox"/>	<input type="checkbox"/>	<input type="checkbox"/>	<input type="checkbox"/>	<input type="checkbox"/>	<input type="checkbox"/>	<input type="checkbox"/>	
	24 x 48 x 72"	WZPT244872	<input type="checkbox"/>	<input type="checkbox"/>	9	<input type="checkbox"/>	<input type="checkbox"/>	<input type="checkbox"/>	<input type="checkbox"/>	<input type="checkbox"/>	<input type="checkbox"/>	<input type="checkbox"/>	<input type="checkbox"/>	<input type="checkbox"/>	
	30 x 48 x 66"	WZPT304866	<input type="checkbox"/>	<input type="checkbox"/>	9	<input type="checkbox"/>	<input type="checkbox"/>	<input type="checkbox"/>	<input type="checkbox"/>	<input type="checkbox"/>	<input type="checkbox"/>	<input type="checkbox"/>	<input type="checkbox"/>	<input type="checkbox"/>	
	30 x 48 x 72"	WZPT304872	<input type="checkbox"/>	<input type="checkbox"/>	9	<input type="checkbox"/>	<input type="checkbox"/>	<input type="checkbox"/>	<input type="checkbox"/>	<input type="checkbox"/>	<input type="checkbox"/>	<input type="checkbox"/>	<input type="checkbox"/>	<input type="checkbox"/>	
 <p>WZWFO</p> <p>Piano Peninsula Worksurface (Right Shown)</p> <ul style="list-style-type: none"> • Long surface is supported by 3" diameter metal support leg with adjustable glide • Connects to either 24" or 30" worksurface • Adjustable glides • Available with 29" height only 	24 x 48 x 60"	WZPP244860	<input type="checkbox"/>	<input type="checkbox"/>	9	<input type="checkbox"/>	<input type="checkbox"/>	<input type="checkbox"/>	<input type="checkbox"/>	<input type="checkbox"/>	<input type="checkbox"/>	<input type="checkbox"/>	<input type="checkbox"/>		
	24 x 48 x 66"	WZPP244866	<input type="checkbox"/>	<input type="checkbox"/>	9	<input type="checkbox"/>	<input type="checkbox"/>	<input type="checkbox"/>	<input type="checkbox"/>	<input type="checkbox"/>	<input type="checkbox"/>	<input type="checkbox"/>	<input type="checkbox"/>		
	24 x 48 x 72"	WZPP244872	<input type="checkbox"/>	<input type="checkbox"/>	9	<input type="checkbox"/>	<input type="checkbox"/>	<input type="checkbox"/>	<input type="checkbox"/>	<input type="checkbox"/>	<input type="checkbox"/>	<input type="checkbox"/>	<input type="checkbox"/>		
	30 x 48 x 66"	WZPP304866	<input type="checkbox"/>	<input type="checkbox"/>	9	<input type="checkbox"/>	<input type="checkbox"/>	<input type="checkbox"/>	<input type="checkbox"/>	<input type="checkbox"/>	<input type="checkbox"/>	<input type="checkbox"/>	<input type="checkbox"/>		
	30 x 48 x 72"	WZPP304872	<input type="checkbox"/>	<input type="checkbox"/>	9	<input type="checkbox"/>	<input type="checkbox"/>	<input type="checkbox"/>	<input type="checkbox"/>	<input type="checkbox"/>	<input type="checkbox"/>	<input type="checkbox"/>	<input type="checkbox"/>		
			A	B	C	D	E	F	G	H	I	J	K	L	M

HOW TO ORDER

Indicate the following information on order form:

- Quantity of each item.
- Model number, including options. See "How To Build a Model Number".
- Any special service required.



Note: • The indicates that a choice is required.
 • The absence of the indicates that no choice is required.
 • Alpha-numeric characters in place of indicates that no other alternatives are available.

HOW TO BUILD A MODEL NUMBER

- A** Select basic model.
- B** Select edge style.
BN - Flat vinyl T-edge
74P - 74P edge
- C** Select surface direction.
R - Right
L - Left
 Direction is determined by the side of the worksurface that has the 3" diameter leg. Calculate side based on user's normal seated position.
- D** Select height.
9 - 29" high
- E** Select horizontal wireway.
NW - No horizontal wireway
WW - Wireway
- F** Select frame style.
WB - w/ Beam
WM - w/ Modesty panel
WF - w/ Full modesty panel
 w/ Full modesty panel (available on 29" high only)
- G** Select location and type of leg.
TS - Standard legs
TL - Transition leg (left)
TR - Transition leg (right)
TB - Transition leg (both)
 Note: If ordering Basic Worksurface as a freestanding unit, or if only one side connects to a transitional worksurface, the "TB" option for both transitional legs is not available.
- H** Select grommet option.
 Grommets are required for overhead cabinet.
OGN - No worksurface grommet
OGY - Yes worksurface grommet
 Grommets can be used for wire pass-through.
- I** Select paint color.
 Refer to Finish Options on page 7.
- J** Select insert color.
 Refer to Finish Options on page 7. Insert color also includes horizontal wireway (WW) if selected.
- K** Select laminate surface.
 Refer to Finish Options on page 7.
- L** Select edge color.
 Refer to Finish Options on page 7. Edge color offerings are based on edge style selections.
- M** Select grommet color.
 Refer to Finish Options on page 7.

FlexStation® Worksurfaces

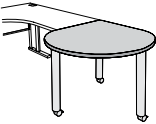
Mobile

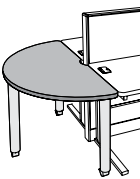
				MODEL NUMBER						
MODEL	Features	D x DIA	Basic Model	Edge Style	Height	Paint Color	Base	Laminate Color	Edge Color	
 <p>Mobile Teardrop Worksurface</p> <ul style="list-style-type: none"> • Base consists of 3" diameter metal support leg with adjustable chrome-plated glide • 3" casters are optional; two are locking • Connects to end of 24" or 30" worksurface • Wireway option not available • 29" height only with or without casters 		24 x 40"	WMT2440	<input type="checkbox"/> <input type="checkbox"/> <input type="checkbox"/>	9	<input type="checkbox"/> <input type="checkbox"/>	<input type="checkbox"/>	<input type="checkbox"/> <input type="checkbox"/> <input type="checkbox"/>	<input type="checkbox"/> <input type="checkbox"/> <input type="checkbox"/>	
		30 x 50"	WMT3050	<input type="checkbox"/> <input type="checkbox"/> <input type="checkbox"/>	9	<input type="checkbox"/> <input type="checkbox"/>	<input type="checkbox"/>	<input type="checkbox"/> <input type="checkbox"/> <input type="checkbox"/>	<input type="checkbox"/> <input type="checkbox"/> <input type="checkbox"/>	
 <p>Mobile Semi-Circle Worksurface</p> <ul style="list-style-type: none"> • Base consists of 3" diameter metal support leg with adjustable chrome-plated glide • Aligns with end of 24" or 30" worksurface • Notched in center for wire management • Wireway option not available • 29" height only with or without casters • 3" casters are optional; two are locking 		24 x 48"	WMSC48	<input type="checkbox"/> <input type="checkbox"/> <input type="checkbox"/>	9	<input type="checkbox"/> <input type="checkbox"/>	<input type="checkbox"/>	<input type="checkbox"/> <input type="checkbox"/> <input type="checkbox"/>	<input type="checkbox"/> <input type="checkbox"/> <input type="checkbox"/>	
		30 x 60"	WMSC60	<input type="checkbox"/> <input type="checkbox"/> <input type="checkbox"/>	9	<input type="checkbox"/> <input type="checkbox"/>	<input type="checkbox"/>	<input type="checkbox"/> <input type="checkbox"/> <input type="checkbox"/>	<input type="checkbox"/> <input type="checkbox"/> <input type="checkbox"/>	
 <p>Mobile Semi-Circle Worksurface w/notch</p> <ul style="list-style-type: none"> • Use with WireWorks panels • Notch enables surface to wrap around end cap of WireWorks panel • 51-1/2" diameter accommodates two 24" deep worksurfaces separated by a WireWorks panel • 63-1/2" diameter accommodates two 30" deep worksurfaces separated by a WireWorks panel • Std. for use with radius WireWorks end caps • Flat for use with WireWorks & Unite flat metal trim 	Std.	24 x 51-1/2"	WMSCPW52	<input type="checkbox"/> <input type="checkbox"/> <input type="checkbox"/>	9	<input type="checkbox"/> <input type="checkbox"/>	<input type="checkbox"/>	<input type="checkbox"/> <input type="checkbox"/> <input type="checkbox"/>	<input type="checkbox"/> <input type="checkbox"/> <input type="checkbox"/>	
	Std.	30 x 63-1/2"	WMSCPW64	<input type="checkbox"/> <input type="checkbox"/> <input type="checkbox"/>	9	<input type="checkbox"/> <input type="checkbox"/>	<input type="checkbox"/>	<input type="checkbox"/> <input type="checkbox"/> <input type="checkbox"/>	<input type="checkbox"/> <input type="checkbox"/> <input type="checkbox"/>	
	Flat	24 x 51-1/2"	WMSCFW52	<input type="checkbox"/> <input type="checkbox"/> <input type="checkbox"/>	9	<input type="checkbox"/> <input type="checkbox"/>	<input type="checkbox"/>	<input type="checkbox"/> <input type="checkbox"/> <input type="checkbox"/>	<input type="checkbox"/> <input type="checkbox"/> <input type="checkbox"/>	
	Flat	30 x 63-1/2"	WMSCFW64	<input type="checkbox"/> <input type="checkbox"/> <input type="checkbox"/>	9	<input type="checkbox"/> <input type="checkbox"/>	<input type="checkbox"/>	<input type="checkbox"/> <input type="checkbox"/> <input type="checkbox"/>	<input type="checkbox"/> <input type="checkbox"/> <input type="checkbox"/>	
				A	B	C	D	E	F	G

HOW TO ORDER

Indicate the following information on order form:

1. Quantity of each item.
2. Model number, including options.
See "How To Build a Model Number".
3. Any special service required.

Note: • The indicates that a choice is required.

- The absence of the indicates that no choice is required.
- Alpha-numeric characters in place of indicates that no other alternatives are available.

HOW TO BUILD A MODEL NUMBER

- A** Select basic model.
- B** Select edge style.
 BN - Flat vinyl T-edge
 74P - 74P edge
- C** Select height.
 9 - 29" high
- D** Select paint color.
 Refer to Finish Options on page 7.
- E** Select base option.
 G - Glides (4 glides)
 C - Casters
- F** Select laminate surface.
 Refer to Finish Options on page 7.
- G** Select edge color.
 Refer to Finish Options on page 7.
 Edge color offerings are based on edge style selections.

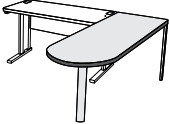
MODEL	D x W	MODEL NUMBER							Approx. Packaged Weight
		Basic Model	Edge Style	Height	Frame Style	Paint Color	Laminate Color	Edge Color	
 <p>Peninsula End Worksurface</p> <ul style="list-style-type: none"> • 3" diameter metal support leg • Wireway option not available • Available with 29" height only 	24 x 48"	WPW2448	<input type="checkbox"/> <input type="checkbox"/> <input type="checkbox"/>	9		<input type="checkbox"/> <input type="checkbox"/>	<input type="checkbox"/> <input type="checkbox"/> <input type="checkbox"/>	<input type="checkbox"/> <input type="checkbox"/> <input type="checkbox"/>	44.0#
	24 x 60"	WPW2460	<input type="checkbox"/> <input type="checkbox"/> <input type="checkbox"/>	9		<input type="checkbox"/> <input type="checkbox"/>	<input type="checkbox"/> <input type="checkbox"/> <input type="checkbox"/>	<input type="checkbox"/> <input type="checkbox"/> <input type="checkbox"/>	57.0#
	24 x 72"	WPW2472	<input type="checkbox"/> <input type="checkbox"/> <input type="checkbox"/>	9		<input type="checkbox"/> <input type="checkbox"/>	<input type="checkbox"/> <input type="checkbox"/> <input type="checkbox"/>	<input type="checkbox"/> <input type="checkbox"/> <input type="checkbox"/>	68.0#
	30 x 48"	WPW3048	<input type="checkbox"/> <input type="checkbox"/> <input type="checkbox"/>	9		<input type="checkbox"/> <input type="checkbox"/>	<input type="checkbox"/> <input type="checkbox"/> <input type="checkbox"/>	<input type="checkbox"/> <input type="checkbox"/> <input type="checkbox"/>	48.0#
	30 x 60"	WPW3060	<input type="checkbox"/> <input type="checkbox"/> <input type="checkbox"/>	9		<input type="checkbox"/> <input type="checkbox"/>	<input type="checkbox"/> <input type="checkbox"/> <input type="checkbox"/>	<input type="checkbox"/> <input type="checkbox"/> <input type="checkbox"/>	63.0#
	30 x 72"	WPW3072	<input type="checkbox"/> <input type="checkbox"/> <input type="checkbox"/>	9		<input type="checkbox"/> <input type="checkbox"/>	<input type="checkbox"/> <input type="checkbox"/> <input type="checkbox"/>	<input type="checkbox"/> <input type="checkbox"/> <input type="checkbox"/>	75.0#
WPWFO									
 <p>Peninsula Side Mount Worksurface</p> <ul style="list-style-type: none"> • 3" diameter metal support leg • When specifying peninsula side mount worksurface a transitional leg must be ordered on the basic surface to which it will connect • Wireway option not available • Available with 29" height only • The selection of with Beam, modesty or full modesty is for the 24 or 30" depth • If a guest side modesty is desired that would need to be specified separately 	24 x 48"	WPW2448S	<input type="checkbox"/> <input type="checkbox"/> <input type="checkbox"/>	9	<input type="checkbox"/> <input type="checkbox"/>	<input type="checkbox"/> <input type="checkbox"/>	<input type="checkbox"/> <input type="checkbox"/> <input type="checkbox"/>	<input type="checkbox"/> <input type="checkbox"/> <input type="checkbox"/>	51.0#
	24 x 60"	WPW2460S	<input type="checkbox"/> <input type="checkbox"/> <input type="checkbox"/>	9	<input type="checkbox"/> <input type="checkbox"/>	<input type="checkbox"/> <input type="checkbox"/>	<input type="checkbox"/> <input type="checkbox"/> <input type="checkbox"/>	<input type="checkbox"/> <input type="checkbox"/> <input type="checkbox"/>	64.0#
	24 x 72"	WPW2472S	<input type="checkbox"/> <input type="checkbox"/> <input type="checkbox"/>	9	<input type="checkbox"/> <input type="checkbox"/>	<input type="checkbox"/> <input type="checkbox"/>	<input type="checkbox"/> <input type="checkbox"/> <input type="checkbox"/>	<input type="checkbox"/> <input type="checkbox"/> <input type="checkbox"/>	77.0#
	30 x 48"	WPW3048S	<input type="checkbox"/> <input type="checkbox"/> <input type="checkbox"/>	9	<input type="checkbox"/> <input type="checkbox"/>	<input type="checkbox"/> <input type="checkbox"/>	<input type="checkbox"/> <input type="checkbox"/> <input type="checkbox"/>	<input type="checkbox"/> <input type="checkbox"/> <input type="checkbox"/>	59.0#
	30 x 60"	WPW3060S	<input type="checkbox"/> <input type="checkbox"/> <input type="checkbox"/>	9	<input type="checkbox"/> <input type="checkbox"/>	<input type="checkbox"/> <input type="checkbox"/>	<input type="checkbox"/> <input type="checkbox"/> <input type="checkbox"/>	<input type="checkbox"/> <input type="checkbox"/> <input type="checkbox"/>	71.0#
	30 x 72"	WPW3072S	<input type="checkbox"/> <input type="checkbox"/> <input type="checkbox"/>	9	<input type="checkbox"/> <input type="checkbox"/>	<input type="checkbox"/> <input type="checkbox"/>	<input type="checkbox"/> <input type="checkbox"/> <input type="checkbox"/>	<input type="checkbox"/> <input type="checkbox"/> <input type="checkbox"/>	83.0#
WPWFO									
			A	B	C	D	E	F	G

HOW TO ORDER

Indicate the following information on order form:

1. Quantity of each item.
2. Model number, including options. See "How To Build a Model Number".
3. Any special service required.

Note: • The indicates that a choice is required.
 • The absence of the indicates that no choice is required.
 • Alpha-numeric characters in place of indicates that no other alternatives are available.

HOW TO BUILD A MODEL NUMBER

- A** Select basic model.
- B** Select edge style.
 - BN** - Flat vinyl T-edge
 - 74P** - 74P edge
- C** Select height.
 - 9** - 29" high
- D** Select frame style.
 - WB** - w/ Beam
 - WM** - w/ Modesty panel
 - WF** - w/ Full modesty panel
- E** Select paint color. Refer to Finish Options on page 7.
- F** Select laminate surface. Refer to Finish Options on page 7.
- G** Select edge color. Refer to Finish Options on page 7. Edge color offerings are based on edge style selections.

FlexStation® Worksurfaces

Transitional

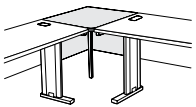
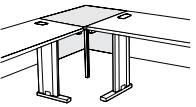
MODEL	D x W	MODEL NUMBER										
		Basic Model	Edge Style	Trans. Dir.	Trans. Height	WWay	Frame Style	Paint Color	Insert Color	Laminate Color	Edge Color	
 <p>Square Transitional Surface</p> <ul style="list-style-type: none"> • Full wrap modesty panel included • For use with fixed height workstations only • Corner support leg is 7/8" square tubular steel 	24 x 24"	WST2424	<input type="checkbox"/> <input type="checkbox"/> <input type="checkbox"/>	<input type="checkbox"/>	<input type="checkbox"/>	<input type="checkbox"/>	<input type="checkbox"/>	<input type="checkbox"/>	<input type="checkbox"/> <input type="checkbox"/> <input type="checkbox"/>	<input type="checkbox"/> <input type="checkbox"/> <input type="checkbox"/>	<input type="checkbox"/> <input type="checkbox"/> <input type="checkbox"/>	
	30 x 30"	WST3030	<input type="checkbox"/> <input type="checkbox"/> <input type="checkbox"/>	<input type="checkbox"/>	<input type="checkbox"/>	<input type="checkbox"/>	<input type="checkbox"/>	<input type="checkbox"/>	<input type="checkbox"/>	<input type="checkbox"/> <input type="checkbox"/> <input type="checkbox"/>	<input type="checkbox"/> <input type="checkbox"/> <input type="checkbox"/>	<input type="checkbox"/> <input type="checkbox"/> <input type="checkbox"/>
WCTFO												
 <p>Rectangle Transitional Surface</p> <ul style="list-style-type: none"> • Full wrap modesty panel included • For use with fixed height workstations only • Corner support leg is 7/8" square tubular steel 	24 x 30"	WRT2430	<input type="checkbox"/> <input type="checkbox"/> <input type="checkbox"/>	<input type="checkbox"/>	<input type="checkbox"/>	<input type="checkbox"/>	<input type="checkbox"/>	<input type="checkbox"/>	<input type="checkbox"/> <input type="checkbox"/> <input type="checkbox"/>	<input type="checkbox"/> <input type="checkbox"/> <input type="checkbox"/>		
	30 x 24"	WRT3024	<input type="checkbox"/> <input type="checkbox"/> <input type="checkbox"/>	<input type="checkbox"/>	<input type="checkbox"/>	<input type="checkbox"/>	<input type="checkbox"/>	<input type="checkbox"/>	<input type="checkbox"/>	<input type="checkbox"/> <input type="checkbox"/> <input type="checkbox"/>	<input type="checkbox"/> <input type="checkbox"/> <input type="checkbox"/>	
WCTFO												
			A	B	C	D	E	F	G	H	I	J

HOW TO ORDER

Indicate the following information on order form:

1. Quantity of each item.
2. Model number, including options. See "How To Build a Model Number".
3. Any special service required.

Note: • The indicates that a choice is required.
 • The absence of the indicates that no choice is required.
 • Alpha-numeric characters in place of indicates that no other alternatives are available.

HOW TO BUILD A MODEL NUMBER

A Select basic model.

B Select edge style.

BN - Flat vinyl T-edge
74P - 74P edge

C Select transition direction.

L - Left
R - Right
X - None

Transition direction is determined from the originating 24" or 30" basic or keyboard pad worksurface. All corner transitional surfaces connected at the same height do not require right (R) or left (L) transition direction. Use "X" for transition direction. Transition height required for "97" transitional.

D Select transition height.

77 - 27" to 27" high
97 - 29" to 27" high
99 - 29" to 29" high

E Select horizontal wireway.

NW - No horizontal wireway
WW - Wireway

F Select frame style.

WB - w/ Beam
WM - w/ Modesty panel
WF - w/ Full modesty panel
 w/ Full modesty panel (available on 29" high only)

G Select paint color.

Refer to Finish Options on page 7.

H Select insert color.

Refer to Finish Options on page 7. Insert color also includes horizontal wireway (WW) if selected.

I Select laminate surface.

Refer to Finish Options on page 7.

J Select edge color.

Refer to Finish Options on page 7. Edge color offerings are based on edge style selections.

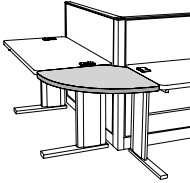
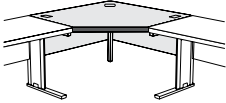
	D x W-LEFT x W-RIGHT x D	MODEL NUMBER												
		Basic Model	Edge Style	Trans. Dir.	Trans. Height	WWay	Frame Style	Grom.	Paint Clr.	Insrt. Clr.	Lam. Clr.	Edge Clr.		Grm. Clr.
 <p>WCTFO Quarter Round Transitional Surface</p> <ul style="list-style-type: none"> • Two splice plates provided • For use with fixed height workstations only • Available with flat vinyl T-edge or 74P edge • For use as conferencing corner • Wireway option not available • Modesty panel not required • 24" surface has radius of 26-2/3" and 30" surface has a radius of 35" 	24 x 24" Dia for Panel	WQRPW24	<input type="checkbox"/>								<input type="checkbox"/>	<input type="checkbox"/>		
	30 x 30" Dia for Panel	WQRPW30	<input type="checkbox"/>								<input type="checkbox"/>	<input type="checkbox"/>		
 <p>WCTFO Corner Transitional Surface</p> <ul style="list-style-type: none"> • For use with fixed height workstations only • Corner support leg is 7/8" sq. tubular steel • Front edge dimension is 17" on 24 x 36" and 30 x 42"; 25-1/2" on 24 x 42" and 30 x 48"; 34" on 24 x 48" • Overheads may not be specified 	24 x 36 x 36 x 24"	WCT2436	<input type="checkbox"/>	<input type="checkbox"/>	<input type="checkbox"/>	<input type="checkbox"/>	<input type="checkbox"/>	<input type="checkbox"/>	<input type="checkbox"/>	<input type="checkbox"/>	<input type="checkbox"/>	<input type="checkbox"/>	<input type="checkbox"/>	
	24 x 42 x 42 x 24"	WCT2442	<input type="checkbox"/>	<input type="checkbox"/>	<input type="checkbox"/>	<input type="checkbox"/>	<input type="checkbox"/>	<input type="checkbox"/>	<input type="checkbox"/>	<input type="checkbox"/>	<input type="checkbox"/>	<input type="checkbox"/>	<input type="checkbox"/>	
	24 x 48 x 48 x 24"	WCT2448	<input type="checkbox"/>	<input type="checkbox"/>	<input type="checkbox"/>	<input type="checkbox"/>	<input type="checkbox"/>	<input type="checkbox"/>	<input type="checkbox"/>	<input type="checkbox"/>	<input type="checkbox"/>	<input type="checkbox"/>	<input type="checkbox"/>	
	30 x 42 x 42 x 30"	WCT3042	<input type="checkbox"/>	<input type="checkbox"/>	<input type="checkbox"/>	<input type="checkbox"/>	<input type="checkbox"/>	<input type="checkbox"/>	<input type="checkbox"/>	<input type="checkbox"/>	<input type="checkbox"/>	<input type="checkbox"/>	<input type="checkbox"/>	
	30 x 48 x 48 x 30"	WCT3048	<input type="checkbox"/>	<input type="checkbox"/>	<input type="checkbox"/>	<input type="checkbox"/>	<input type="checkbox"/>	<input type="checkbox"/>	<input type="checkbox"/>	<input type="checkbox"/>	<input type="checkbox"/>	<input type="checkbox"/>	<input type="checkbox"/>	
			A	B	C	D	E	F	G	H	I	J	K	L

HOW TO ORDER

Indicate the following information on order form:

- Quantity of each item.
- Model number, including options. See "How To Build a Model Number".
- Any special service required.

Note: • The indicates that a choice is required.
 • The absence of the indicates that no choice is required.
 • Alpha-numeric characters in place of indicates that no other alternatives are available.

HOW TO BUILD A MODEL NUMBER

- A** Select basic model.
- B** Select edge style.
BN - Flat vinyl T-edge
74P - 74P edge
- C** Select transition direction.
L - Left
R - Right
X - None
 Transition direction is determined from the originating 24" or 30" basic or keyboard pad worksurface. All corner transitional surfaces connected at the same height do not require right (R) or left (L) transition direction. Use "X" for transition direction. Transition height required for "97" transitional.
- D** Select transition height.
77 - 27" to 27" high
97 - 29" to 27" high
99 - 29" to 29" high
- E** Select horizontal wireway.
NW - No horizontal wireway
WW - Wireway
- F** Select frame style.
WB - w/ Beam
WM - w/ Modesty panel
WF - w/ Full modesty panel
 w/ Full modesty panel (available on 29" high only)
- G** Select grommet option.
 Grommets are required for overhead cabinet.
OGN - No worksurface grommet
OGY - Yes worksurface grommet
 Grommets can be used for wire pass-through.
- H** Select paint color.
 Refer to Finish Options on page 7.
- I** Select insert color.
 Refer to Finish Options on page 7. Insert color also includes horizontal wireway (WW) if selected.
- J** Select laminate surface.
 Refer to Finish Options on page 7.
- K** Select edge color.
 Refer to Finish Options on page 7. Edge color offerings are based on edge style selections.
- L** Select grommet color.
 Refer to Finish Options on page 7.

FlexStation® Worksurfaces

Transitional

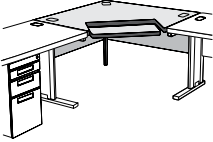
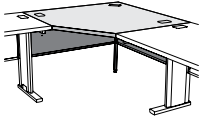
D x W-LEFT x W-RIGHT x D	MODEL NUMBER													
	Basic Model	Edge Style	Trans. Dir.	Trans. Height	WWay	Frame Style	Grom.	Paint Clr.	Insrt. Clr.	Lam. Clr.	Edge Clr.	Grm. Clr.		
 <p>WCTFO Corner Transitional Surface with Keyboard Pad</p> <ul style="list-style-type: none"> • Keyboard pad: 10" x 24"; 3" height adjustments: 1" forward extension adjustment: 15° maximum downward tilt • For use with fixed height workstations only • Corner support leg is 7/8" sq. tubular steel • Overheads may not be specified 	24 x 42 x 42 x 24"	WCTK2442	<input type="checkbox"/>	<input type="checkbox"/>	<input type="checkbox"/>	<input type="checkbox"/>	<input type="checkbox"/>	<input type="checkbox"/>	<input type="checkbox"/>	<input type="checkbox"/>	<input type="checkbox"/>	<input type="checkbox"/>	<input type="checkbox"/>	
	24 x 48 x 48 x 24"	WCTK2448	<input type="checkbox"/>	<input type="checkbox"/>	<input type="checkbox"/>	<input type="checkbox"/>	<input type="checkbox"/>	<input type="checkbox"/>	<input type="checkbox"/>	<input type="checkbox"/>	<input type="checkbox"/>	<input type="checkbox"/>	<input type="checkbox"/>	
	30 x 48 x 48 x 30"	WCTK3048	<input type="checkbox"/>	<input type="checkbox"/>	<input type="checkbox"/>	<input type="checkbox"/>	<input type="checkbox"/>	<input type="checkbox"/>	<input type="checkbox"/>	<input type="checkbox"/>	<input type="checkbox"/>	<input type="checkbox"/>	<input type="checkbox"/>	
 <p>WCTFO Corner Transitional Reduction Surface</p> <ul style="list-style-type: none"> • For use with fixed height workstations only • Corner support leg is 7/8" sq. tubular steel • Used to join 24" and 30" deep worksurfaces in corner • Overheads may not be specified 	24 x 42 x 42 x 30"	WCT244230	<input type="checkbox"/>	<input type="checkbox"/>	<input type="checkbox"/>	<input type="checkbox"/>	<input type="checkbox"/>	<input type="checkbox"/>	<input type="checkbox"/>	<input type="checkbox"/>	<input type="checkbox"/>	<input type="checkbox"/>		
	24 x 48 x 48 x 30"	WCT244830	<input type="checkbox"/>	<input type="checkbox"/>	<input type="checkbox"/>	<input type="checkbox"/>	<input type="checkbox"/>	<input type="checkbox"/>	<input type="checkbox"/>	<input type="checkbox"/>	<input type="checkbox"/>	<input type="checkbox"/>		
	30 x 42 x 42 x 24"	WCT304224	<input type="checkbox"/>	<input type="checkbox"/>	<input type="checkbox"/>	<input type="checkbox"/>	<input type="checkbox"/>	<input type="checkbox"/>	<input type="checkbox"/>	<input type="checkbox"/>	<input type="checkbox"/>	<input type="checkbox"/>		
	30 x 48 x 48 x 24"	WCT304824	<input type="checkbox"/>	<input type="checkbox"/>	<input type="checkbox"/>	<input type="checkbox"/>	<input type="checkbox"/>	<input type="checkbox"/>	<input type="checkbox"/>	<input type="checkbox"/>	<input type="checkbox"/>	<input type="checkbox"/>		
			A	B	C	D	E	F	G	H	I	J	K	L

HOW TO ORDER

Indicate the following information on order form:

1. Quantity of each item.
2. Model number, including options. See "How To Build a Model Number".
3. Any special service required.

Note: • The indicates that a choice is required.
 • The absence of the indicates that no choice is required.
 • Alpha-numeric characters in place of indicates that no other alternatives are available.

HOW TO BUILD A MODEL NUMBER

A Select basic model.

B Select edge style.

BN - Flat vinyl T-edge
74P - 74P edge

C Select transition direction.

L - Left
R - Right
X - None

Transition direction is determined from the originating 24" or 30" basic or keyboard pad worksurface. All corner transitional surfaces connected at the same height do not require right (R) or left (L) transition direction. Use "X" for transition direction. Transition height required for "97" transitional.

D Select transition height.

77 - 27" to 27" high
97 - 29" to 27" high
99 - 29" to 29" high

E Select horizontal wireway.

NW - No horizontal wireway
WW - Wireway

F Select frame style.

WB - w/ Beam
WM - w/ Modesty panel
WF - w/ Full modesty panel
 w/ Full modesty panel (available on 29" high only)

G Select grommet option.

Grommets are required for overhead cabinet.
OGN - No worksurface grommet
OGY - Yes worksurface grommet
 Grommets can be used for wire pass-through.

H Select paint color.

Refer to Finish Options on page 7.

I Select insert color.

Refer to Finish Options on page 7. Insert color also includes horizontal wireway (WW) if selected.

J Select laminate surface.

Refer to Finish Options on page 7.

K Select edge color.

Refer to Finish Options on page 7. Edge color offerings are based on edge style selections.

L Select grommet color.

Refer to Finish Options on page 7.

FlexStation® Worksurfaces

Transitional

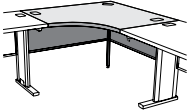
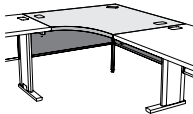
	D x W-LEFT x W-RIGHT x D	MODEL NUMBER												
		Basic Model	Edge Style	Trans. Dir.	Trans. Height	WWay	Frame Style	Grom.	Paint Color	Insrt.Clr.	Lam. Clr.	Edge Clr.	Grm. Clr.	
 <p>WCTFO</p> <p>Corner Curvilinear Transitional Surface</p> <ul style="list-style-type: none"> For use with fixed height workstations only Corner support leg is 7/8" sq. tubular steel Curved front surface Overheads may not be specified 	24 x 36 x 36 x 24"	WCCT2436	<input type="checkbox"/>	<input type="checkbox"/>	<input type="checkbox"/>	<input type="checkbox"/>	<input type="checkbox"/>	<input type="checkbox"/>	<input type="checkbox"/>	<input type="checkbox"/>	<input type="checkbox"/>	<input type="checkbox"/>	<input type="checkbox"/>	
	24 x 42 x 42 x 24"	WCCT2442	<input type="checkbox"/>	<input type="checkbox"/>	<input type="checkbox"/>	<input type="checkbox"/>	<input type="checkbox"/>	<input type="checkbox"/>	<input type="checkbox"/>	<input type="checkbox"/>	<input type="checkbox"/>	<input type="checkbox"/>	<input type="checkbox"/>	
	24 x 48 x 48 x 24"	WCCT2448	<input type="checkbox"/>	<input type="checkbox"/>	<input type="checkbox"/>	<input type="checkbox"/>	<input type="checkbox"/>	<input type="checkbox"/>	<input type="checkbox"/>	<input type="checkbox"/>	<input type="checkbox"/>	<input type="checkbox"/>	<input type="checkbox"/>	
	30 x 42 x 42 x 30"	WCCT3042	<input type="checkbox"/>	<input type="checkbox"/>	<input type="checkbox"/>	<input type="checkbox"/>	<input type="checkbox"/>	<input type="checkbox"/>	<input type="checkbox"/>	<input type="checkbox"/>	<input type="checkbox"/>	<input type="checkbox"/>	<input type="checkbox"/>	
	30 x 48 x 48 x 30"	WCCT3048	<input type="checkbox"/>	<input type="checkbox"/>	<input type="checkbox"/>	<input type="checkbox"/>	<input type="checkbox"/>	<input type="checkbox"/>	<input type="checkbox"/>	<input type="checkbox"/>	<input type="checkbox"/>	<input type="checkbox"/>	<input type="checkbox"/>	
 <p>WCTFO</p> <p>Corner Curvilinear Transitional Reduction Surface</p> <ul style="list-style-type: none"> For use with fixed height workstations only Corner support leg is 7/8" sq. tubular steel Used to join 24" and 30" worksurfaces in corner Curved front surface Overheads may not be specified 	24 x 42 x 42 x 30"	WCCT244230	<input type="checkbox"/>	<input type="checkbox"/>	<input type="checkbox"/>	<input type="checkbox"/>	<input type="checkbox"/>	<input type="checkbox"/>	<input type="checkbox"/>	<input type="checkbox"/>	<input type="checkbox"/>	<input type="checkbox"/>		
	24 x 48 x 48 x 30"	WCCT244830	<input type="checkbox"/>	<input type="checkbox"/>	<input type="checkbox"/>	<input type="checkbox"/>	<input type="checkbox"/>	<input type="checkbox"/>	<input type="checkbox"/>	<input type="checkbox"/>	<input type="checkbox"/>	<input type="checkbox"/>		
	30 x 42 x 42 x 24"	WCCT304224	<input type="checkbox"/>	<input type="checkbox"/>	<input type="checkbox"/>	<input type="checkbox"/>	<input type="checkbox"/>	<input type="checkbox"/>	<input type="checkbox"/>	<input type="checkbox"/>	<input type="checkbox"/>	<input type="checkbox"/>		
	30 x 48 x 48 x 24"	WCCT304824	<input type="checkbox"/>	<input type="checkbox"/>	<input type="checkbox"/>	<input type="checkbox"/>	<input type="checkbox"/>	<input type="checkbox"/>	<input type="checkbox"/>	<input type="checkbox"/>	<input type="checkbox"/>	<input type="checkbox"/>		
			A	B	C	D	E	F	G	H	I	J	K	L

HOW TO ORDER

Indicate the following information on order form:

- Quantity of each item.
- Model number, including options. See "How To Build a Model Number".
- Any special service required.

Note:

- The indicates that a choice is required.
- The absence of the indicates that no choice is required.
- Alpha-numeric characters in place of indicates that no other alternatives are available.

HOW TO BUILD A MODEL NUMBER

A Select basic model.

B Select edge style.

BN - Flat vinyl T-edge
74P - 74P edge

C Select transition direction.

L - Left
R - Right
X - None

Transition direction is determined from the originating 24" or 30" basic or keyboard pad worksurface. All corner transitional surfaces connected at the same height do not require right (R) or left (L) transition direction. Use "X" for transition direction. Transition height required for "97" transitional.

D Select transition height.

77 - 27" to 27" high
97 - 29" to 27" high
99 - 29" to 29" high

E Select horizontal wireway.

NW - No horizontal wireway
WW - Wireway

F Select frame style.

WB - w/ Beam
WM - w/ Modesty panel
WF - w/ Full modesty panel
w/ Full modesty panel (available on 29" high only)

G Select grommet option.

Grommets are required for overhead cabinet.
OGN - No worksurface grommet
OGY - Yes worksurface grommet
Grommets can be used for wire pass-through.

H Select paint color.

Refer to Finish Options on page 7.

I Select insert color.

Refer to Finish Options on page 7. Insert color also includes horizontal wireway (WW) if selected.

J Select laminate surface.

Refer to Finish Options on page 7.

K Select edge color.

Refer to Finish Options on page 7. Edge color offerings are based on edge style selections.

L Select grommet color.

Refer to Finish Options on page 7.

FlexStation® Worksurfaces

Transitional

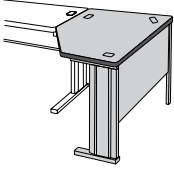
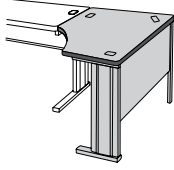
D x W-LEFT x W-RIGHT x D	MODEL NUMBER												
	Basic Model	Edge Style	Trans. Dir.	Hgt.	WWay	Frame Style	Wrksrf. Grom.	Paint Color	Insert Color	Lam. Color	Edge Color	Grom. Color	
 24 x 36 x 36 x 24"	WER2436	<input type="checkbox"/>	<input type="checkbox"/>	<input type="checkbox"/>	<input type="checkbox"/>	<input type="checkbox"/>	<input type="checkbox"/>	<input type="checkbox"/>	<input type="checkbox"/>	<input type="checkbox"/>	<input type="checkbox"/>	<input type="checkbox"/>	
24 x 42 x 42 x 24"	WER2442	<input type="checkbox"/>	<input type="checkbox"/>	<input type="checkbox"/>	<input type="checkbox"/>	<input type="checkbox"/>	<input type="checkbox"/>	<input type="checkbox"/>	<input type="checkbox"/>	<input type="checkbox"/>	<input type="checkbox"/>	<input type="checkbox"/>	
24 x 48 x 48 x 24"	WER2448	<input type="checkbox"/>	<input type="checkbox"/>	<input type="checkbox"/>	<input type="checkbox"/>	<input type="checkbox"/>	<input type="checkbox"/>	<input type="checkbox"/>	<input type="checkbox"/>	<input type="checkbox"/>	<input type="checkbox"/>	<input type="checkbox"/>	
30 x 42 x 42 x 30"	WER3042	<input type="checkbox"/>	<input type="checkbox"/>	<input type="checkbox"/>	<input type="checkbox"/>	<input type="checkbox"/>	<input type="checkbox"/>	<input type="checkbox"/>	<input type="checkbox"/>	<input type="checkbox"/>	<input type="checkbox"/>	<input type="checkbox"/>	
30 x 48 x 48 x 30"	WER3048	<input type="checkbox"/>	<input type="checkbox"/>	<input type="checkbox"/>	<input type="checkbox"/>	<input type="checkbox"/>	<input type="checkbox"/>	<input type="checkbox"/>	<input type="checkbox"/>	<input type="checkbox"/>	<input type="checkbox"/>	<input type="checkbox"/>	
WERFO													
End-of-Run Corner Surface													
<ul style="list-style-type: none"> For use with fixed height workstations only Corner support leg is 7/8" square tubular steel Corner Overheads (Universal or Balance®) may only be specified on the full-leg side 													
 24 x 36 x 36 x 24"	WCCE2436	<input type="checkbox"/>	<input type="checkbox"/>	<input type="checkbox"/>	<input type="checkbox"/>	<input type="checkbox"/>	<input type="checkbox"/>	<input type="checkbox"/>	<input type="checkbox"/>	<input type="checkbox"/>	<input type="checkbox"/>	<input type="checkbox"/>	
24 x 42 x 42 x 24"	WCCE2442	<input type="checkbox"/>	<input type="checkbox"/>	<input type="checkbox"/>	<input type="checkbox"/>	<input type="checkbox"/>	<input type="checkbox"/>	<input type="checkbox"/>	<input type="checkbox"/>	<input type="checkbox"/>	<input type="checkbox"/>	<input type="checkbox"/>	
24 x 48 x 48 x 24"	WCCE2448	<input type="checkbox"/>	<input type="checkbox"/>	<input type="checkbox"/>	<input type="checkbox"/>	<input type="checkbox"/>	<input type="checkbox"/>	<input type="checkbox"/>	<input type="checkbox"/>	<input type="checkbox"/>	<input type="checkbox"/>	<input type="checkbox"/>	
30 x 42 x 42 x 30"	WCCE3042	<input type="checkbox"/>	<input type="checkbox"/>	<input type="checkbox"/>	<input type="checkbox"/>	<input type="checkbox"/>	<input type="checkbox"/>	<input type="checkbox"/>	<input type="checkbox"/>	<input type="checkbox"/>	<input type="checkbox"/>	<input type="checkbox"/>	
30 x 48 x 48 x 30"	WCCE3048	<input type="checkbox"/>	<input type="checkbox"/>	<input type="checkbox"/>	<input type="checkbox"/>	<input type="checkbox"/>	<input type="checkbox"/>	<input type="checkbox"/>	<input type="checkbox"/>	<input type="checkbox"/>	<input type="checkbox"/>	<input type="checkbox"/>	
WERFO													
End-of-Run Curvilinear Surface													
<ul style="list-style-type: none"> For use with fixed height workstations only Corner support leg is 7/8" square tubular steel Corner Overheads (Universal or Balance®) may only be specified on the full-leg side 													
A B C D E F G H I J K L													

HOW TO ORDER

Indicate the following information on order form:

- Quantity of each item.
- Model number, including options. See "How To Build a Model Number".
- Any special service required.

Note: • The indicates that a choice is required.



- The absence of the indicates that no choice is required.
- Alpha-numeric characters in place of indicates that no other alternatives are available.

HOW TO BUILD A MODEL NUMBER

- A** Select basic model.
- B** Select edge style.
BN - Flat vinyl T-edge
74P - 74P edge
- C** Select transition direction.
L - Left
R - Right
 Transition direction is determined from the originating 24" or 30" basic or keyboard pad worksurface. When ordering an End-of-Run worksurface, the adjoining worksurface must have a transitional leg. Order a right (R) or left (L) transitional.
- D** Select height.
7 - 27" high
9 - 29" high
- E** Select horizontal wireway.
NW - No horizontal wireway
WW - Wireway
- F** Select frame style.
WB - w/ Beam
WM - w/ Modesty panel
WF - w/ Full modesty panel
 w/ Full modesty panel (available on 29" high only)
- G** Select grommet option.
 Grommets are required for overhead cabinet.
OGN - No worksurface grommet
OGY - Yes worksurface grommet
 Grommets can be used for wire pass-through.
- H** Select paint color.
 Refer to Finish Options on page 7.
- I** Select insert color.
 Refer to Finish Options on page 7. Insert color also includes horizontal wireway (WW) if selected.
- J** Select laminate surface.
 Refer to Finish Options on page 7.
- K** Select edge color.
 Refer to Finish Options on page 7. Edge color offerings are based on edge style selections.
- L** Select grommet color.
 Refer to Finish Options on page 7.

FlexStation® Worksurfaces

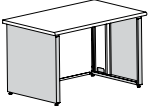
Accessories and Worksurface Connectors

	MODEL	Size	D x W	MODEL NUMBER		Approx. Packaged Weight	
				Basic Model	Paint Color		
	Full Leg End Panel <ul style="list-style-type: none"> • Single end panel • Non-handed works as either left or right-handed • Attaches over existing desk leg 		24 x 29"	WBW24FEP	<input type="checkbox"/>	3.0#	
			30 x 29"	WBW30FEP	<input type="checkbox"/>	4.0#	
WFEP							
	Guest Modesty Panel <ul style="list-style-type: none"> • Can be used on any peninsula or square shoe other than FlexStation® Instruct Desk • Non-handed works as either left or right-handed 		For 60"	9 x 50"	WZMP60	<input type="checkbox"/>	3.0#
			66"	9 x 56"	WZMP66	<input type="checkbox"/>	3.5#
			72"	9 x 62"	WZMP72	<input type="checkbox"/>	4.0#
			84"	9 x 74"	WZMP84	<input type="checkbox"/>	4.5#
HRDPT							
HRDPT	Worksurface Height Change Connectors <ul style="list-style-type: none"> • Attaches 27" - 29" high worksurfaces • Can't be used with "T6" option 			87.4624	<input type="checkbox"/>	2.0#	

A

B

HOW TO ORDER

Indicate the following information on order form:

1. Quantity of each item.
2. Model number, including options. See "How To Build a Model Number".
3. Any special service required.

Note: • The indicates that a choice is required.

- The absence of the indicates that no choice is required.
- Alpha-numeric characters in place of indicates that no other alternatives are available.

HOW TO BUILD A MODEL NUMBER

- A** Select basic model.
- B** Select paint color.
Refer to Finish Options on page 7.

FlexStation® Components

General Information



Universal Overhead Cabinet (WZUS)

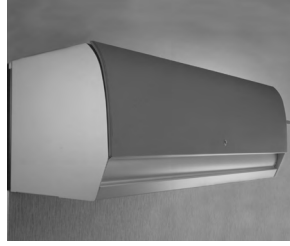

Venus® Overhead Cabinet (VNOS)

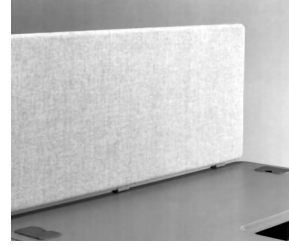

Privacy Screens (WZP)

Features

Solid color/translucent door		•
Fabric door	•	•
Laminate door	•	•
Steel door	•	
Fully assembled		•
Task light	•	•
Hanging tackboard	•	•
Hanging tool rail	•	•
Fabric covered screen		•
Field installable		•

SPECIFICATIONS

Universal Overhead Cabinets

Overhead storage shall consist of overhead cabinet(s) and shelves. Overhead storage shall attach to worksurface with two overhead support stanchions for 30", 36", 42", 48", 54" and 60" sizes. Three overhead support stanchions for 66" and 72" sizes. 66" overheads shall consist of a 30" and 36" overhead combination. 72" overheads shall consist of a pair of 36" overheads.

Shelf dividers shall be powder-coated steel with installation and removal accomplished without the use of tools or fasteners.

Universal overheads and shelves shall be 17" high and shall have 19-1/2" clearance between the worksurface and the bottom of shelf. Overhead doors shall be available with painted steel, fabric, laminate, or veneer, with a PVC extrusion handle. Locks shall be randomly assigned or keyed per customer requests. The end panels shall be constructed of 14-gauge steel and have self-locking mounting tabs

formed into the back edge. The shelf, back, and top shall be constructed from 18-gauge steel.

Venus® Overhead Cabinets

Overhead storage shall consist of overhead cabinet. Overhead storage shall attach to worksurface with two overhead support stanchions for 30", 36", 42", 48", 54", 60", 66" and 72" sizes.

Shelf dividers shall be powder-coated steel with installation and removal accomplished without the use of tools or fasteners.

Balance® overheads shall be 17" high and have 19-1/2" clearance between the worksurface and the bottom of shelf. The upper door shall be available in colored or translucent extruded rigid PVC with spatter-coat finish, fabric, or laminate applied. The overall door thickness shall be 3/8". The lower door shall be an aluminum extrusion and be ergonomic in design. A center lock mechanism shall be utilized between the upper and the lower doors for security. The overhead doors shall be effortlessly operated from either a seated or

standing position through use of the upper or lower door. The upper door and lower door shall be synchronized in motion through the use of two 10-gauge linkages. The doors shall be assisted with two extension springs and require less than 5 pounds of force to operate. The upper door shall open over the outside of the case.

Privacy Screens (WZP)

Two or three 1/8" cold rolled steel brackets, sandwiched between two 1/2" Korlite boards joined together with industrial adhesive. The screens attach to the back of the worksurface with fasteners. Steel splice plates are used to align adjoining screens. Privacy screen is 19-1/2" high above the worksurface.

Privacy Screens (WZPE)

WZPE privacy screens are constructed the same as the WZP screens. The WZPE are mounted to the end of the worksurface and perpendicular to the overheads. These screens are 1" shorter to accommodate the opening of the overhead door.

Key Options

There are various key options available depending on the component model. The key alike option (KA) allows multiple components of a workstation to be keyed alike. The lock number can be specified. The key standard option (KS) allows each component to have its own randomly selected key number shipped with the individual component. The no lock core option (NLC) provides more flexibility in keying workstations alike. All locks and keys for the individual components specified with no lock core will be packaged separately from the components. The location of the lock core and corresponding numbered key will be determined upon installation.

Fabric

Fabric will be applied as swatched by the fabric manufacturer. Fabric that is required to be applied differently than is swatched will need a Special Cost Request written specifying the direction the fabric is to be applied. The posted standard lead time will apply to the Special Cost Request.

BLCS, BLCL, BLCF Models:

Overhead Width	Door Overhang In Open Position	No. Of Doors	Inside Width of Overhead	Dimension Between Side Sets at Worksurface
30"	3"	1	27 ³ / ₄ "	27"
36"	3"	1	33 ³ / ₄ "	33"
42"	3"	1	39 ³ / ₄ "	39"
48"	3"	1	45 ³ / ₄ "	45"
54"	3"	1	51 ³ / ₄ "	51"
60"	3"	1	57 ³ / ₄ "	57"
66"	3"	2	2 x 27 ³ / ₄ "	2 x 28"
72"	3"	2	2 x 33 ³ / ₄ "	2 x 34"

Overall height from worksurface to top of overhead is 36".
 Overhead top slants upward 1" from the back to the door.
 Overhead allows for 19-1/2" clearance from worksurface to underside of shelf.

WZUS, WZUF, WZUL Models:

Overhead Width	Door Overhang In Open Position	No. Of Doors	Inside Width of Overhead	Dimension Between Side Sets at Worksurface
30"	4"	1	29 ¹ / ₂ "	27"
36"	4"	1	35 ¹ / ₂ "	33"
42"	4"	1	41 ¹ / ₂ "	39"
48"	4"	1	47 ¹ / ₂ "	45"
54"	4"	1	53 ¹ / ₂ "	51"
60"	4"	1	59 ¹ / ₂ "	57"
66"	4"	2	1 x 29 ¹ / ₂ " 1 x 35 ¹ / ₂ "	1 x 28" 1 x 34"
72"	4"	2	2 x 35 ¹ / ₂ "	2 x 34"

Overall height from worksurface to top of overhead is 36".
 Overhead allows for 19-1/2" clearance from worksurface to underside of shelf.

FlexStation® Components

Universal Overhead Storage

	MODEL	W x H	MODEL NUMBER		Approx. Packaged Weight
			Basic Model	Paint Color	
 HRDPT	Universal Shelf Divider <ul style="list-style-type: none"> Steel shelf dividers with powder-coated finish Fits shelves and cabinet: WUSS, WZUS, WZUF and WZUL Quantity of 1 per pack 	7-1/4 x 11-1/2"	NSD	<input type="checkbox"/> <input type="checkbox"/>	1.0#
			A	B	

HOW TO ORDER

Indicate the following information on order form:

- Quantity of each item.
- Model number, including options.
See "How To Build a Model Number".
- Any special service required.

Note:

- The indicates that a choice is required.
- The absence of the indicates that no choice is required.
- Alpha-numeric characters in place of indicates that no other alternatives are available.

HOW TO BUILD A MODEL NUMBER

- Select basic model.
- Select paint color.
Refer to Finish Options on page 7.

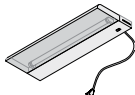
MODEL	W	MODEL NUMBER		Approx. Packaged Weight
		Basic Model		
 <p>Universal Overhead Task Light</p> <ul style="list-style-type: none"> • Electronic ballast • Black only • Includes mounting brackets 	24"	TLT5.24		3.9#
	36"	TLT5.36		5.3#
	48"	TLT5.48		6.7#

HRDPT



HOW TO ORDER

Indicate the following information on order form:

1. Quantity of each item.
2. Model number, including options.
See "How To Build a Model Number".
3. Any special service required.

Note: • The indicates that a choice is required.
 • The absence of the indicates that no choice is required.
 • Alpha-numeric characters in place of indicates that no other alternatives are available.

HOW TO BUILD A MODEL NUMBER

- A** Select basic model.

INFORMATION

TASK LIGHT CABINET WIDTH

Cabinet Width	Light Width
24"	18"
30"	24"
36"	24"
42"	36"
48"	36"
54"	48"
60"	48"
66"	(2)24"
72"	(2)24"

FlexStation® Components

Venus® Overhead Storage

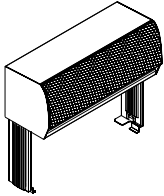
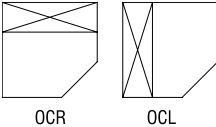
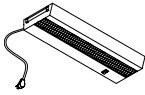
MODEL	W	MODEL NUMBER						Approx. Packaged Weight
		Basic Model	Assembly	Overhead Type	Cabinet Paint Color	Fabric Color	Key Option	
 <p>Venus® Overhead Cabinet with Fabric Upper Door</p> <ul style="list-style-type: none"> • Stanchions and mounting brackets included • The Venus® Overhead allows users the option to interchange from a FlexStation® desk mount solution to an office panel system • Fabric covered light tone upper door • Painted cabinet and lower door • Shelf dividers available separately • Cabinet is fully assembled • Door stores above top of cabinet • 66" and 72" wide overhead are not available on FlexStation® frames with beams. 	30"	VNOF30FS		OS			46#	
	36"	VNOF36FS					52#	
	42"	VNOF42FS					58#	
	48"	VNOF48FS					64#	
	54"	VNOF54FS		OS			70#	
	60"	VNOF60FS		OS			78#	
	66"	VNOF66DFS		OS			91#	
	72"	VNOF72DFS		OS			104#	
 <p>OCR-OCL</p> <ul style="list-style-type: none"> • OCR = Overhead right • OCL = Overhead left 								
 <p>Venus® Overhead Task Light</p> <ul style="list-style-type: none"> • Electronic ballast • Black only • Includes mounting brackets 	24"	BTLT5.24						3.9#
	36"	BTLT5.36						5.3#
	48"	BTLT5.48						6.7#
			A	B	C	D	E	F

HOW TO ORDER

Indicate the following information on order form:

- Quantity of each item.
- Model number, including options.
See "How To Build a Model Number".
- Any special service required.

Note: • The indicates that a choice is required.
• The absence of the indicates that no choice is required.
• Alpha-numeric characters in place of indicates that no other alternatives are available.

HOW TO BUILD A MODEL NUMBER

- A** Select basic model.
- B** Select assembly option.
- | | | |
|--------------------------|-------------|-----------------------------|
| <input type="checkbox"/> | KD2 | - Knock down without fabric |
| <input type="checkbox"/> | VNOF | - Assembled |
- C** Select overhead type.
- | | | |
|--------------------------|------------|-------------------------|
| <input type="checkbox"/> | OCL | - Corner overhead left |
| <input type="checkbox"/> | OCR | - Corner overhead right |
| <input type="checkbox"/> | OS | - Overhead standard |
- D** Select cabinet paint color.
Refer to Finish Options on page 7.
- E** Select upper door fabric.
- F** Select key option.
- | | | |
|--------------------------|------------|----------------|
| <input type="checkbox"/> | KA | - Key alike |
| <input type="checkbox"/> | KS | - Key standard |
| <input type="checkbox"/> | NLC | - No lock core |

INFORMATION

TASK LIGHT CABINET WIDTH

Cabinet Width	Light Width
24"	18"
30"	24"
36"	24"
42"	36"
48"	36"
54"	48"
60"	48"
66"	(2)24"
72"	(2)24"

FlexStation® Components

Overhead Cabinet

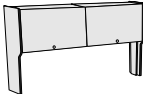
MODEL	W x H x D	MODEL NUMBER					Approx. Packaged Weight	
		Basic Model	Assembly	Trim Color	Laminate Color	Key Option		
 <p>Overhead Cabinet</p> <ul style="list-style-type: none"> • Solid core construction with plastic laminate • Enamel finish on metal parts • Cabinet doors have laminated or upholstered surface with flat vinyl edge • Concealed vertical wire management • Secured to steel legs by concealed mounting brackets • Field installable to compatible FlexStation® worksurfaces • Key-different (standard) or key-alike (optional) to match other overheads and/or pedestals (Specify which items need to be key-alike on order.) • For use with fixed height workstations only • Overhead allows for 18-1/2" clearance above worksurface • Overall height is 34-1/4" • Cannot be mounted on tables with casters • Select size of overhead. Length of overhead must be identical to length of worksurface • 54", 60", 66" and 72" overheads consist of two doors 	30 x 16-1/2 x 14-1/2"	WOC30	<input type="checkbox"/>	<input type="checkbox"/>	<input type="checkbox"/>	<input type="checkbox"/>	73#	
	36 x 16-1/2 x 14-1/2"	WOC36	<input type="checkbox"/>	<input type="checkbox"/>	<input type="checkbox"/>	<input type="checkbox"/>	81#	
	42 x 16-1/2 x 14-1/2"	WOC42	<input type="checkbox"/>	<input type="checkbox"/>	<input type="checkbox"/>	<input type="checkbox"/>	89#	
	48 x 16-1/2 x 14-1/2"	WOC48	<input type="checkbox"/>	<input type="checkbox"/>	<input type="checkbox"/>	<input type="checkbox"/>	99#	
	54 x 16-1/2 x 14-1/2"	WOC54	<input type="checkbox"/>	<input type="checkbox"/>	<input type="checkbox"/>	<input type="checkbox"/>	107#	
	60 x 16-1/2 x 14-1/2"	WOC60	<input type="checkbox"/>	<input type="checkbox"/>	<input type="checkbox"/>	<input type="checkbox"/>	116#	
	66 x 16-1/2 x 14-1/2"	WOC66	<input type="checkbox"/>	<input type="checkbox"/>	<input type="checkbox"/>	<input type="checkbox"/>	137#	
	72 x 16-1/2 x 14-1/2"	WOC72	<input type="checkbox"/>	<input type="checkbox"/>	<input type="checkbox"/>	<input type="checkbox"/>	157#	
	30 x 16-1/2 x 14-1/2"	WOC30-F	<input type="checkbox"/>	<input type="checkbox"/>	<input type="checkbox"/>	<input type="checkbox"/>	73#	
	36 x 16-1/2 x 14-1/2"	WOC36-F	<input type="checkbox"/>	<input type="checkbox"/>	<input type="checkbox"/>	<input type="checkbox"/>	81#	
	42 x 16-1/2 x 14-1/2"	WOC42-F	<input type="checkbox"/>	<input type="checkbox"/>	<input type="checkbox"/>	<input type="checkbox"/>	89#	
	48 x 16-1/2 x 14-1/2"	WOC48-F	<input type="checkbox"/>	<input type="checkbox"/>	<input type="checkbox"/>	<input type="checkbox"/>	99#	
	54 x 16-1/2 x 14-1/2"	WOC54-F	<input type="checkbox"/>	<input type="checkbox"/>	<input type="checkbox"/>	<input type="checkbox"/>	107#	
	60 x 16-1/2 x 14-1/2"	WOC60-F	<input type="checkbox"/>	<input type="checkbox"/>	<input type="checkbox"/>	<input type="checkbox"/>	116#	
	66 x 16-1/2 x 14-1/2"	WOC66-F	<input type="checkbox"/>	<input type="checkbox"/>	<input type="checkbox"/>	<input type="checkbox"/>	137#	
	72 x 16-1/2 x 14-1/2"	WOC72-F	<input type="checkbox"/>	<input type="checkbox"/>	<input type="checkbox"/>	<input type="checkbox"/>	157#	
			A	B	C	D	E	

HOW TO ORDER

Indicate the following information on order form:

1. Quantity of each item.
2. Model number, including options. See "How To Build a Model Number".
3. Any special service required.

Note: • The indicates that a choice is required.

- The absence of the indicates that no choice is required.
- Alpha-numeric characters in place of indicates that no other alternatives are available.

HOW TO BUILD A MODEL NUMBER

- A** Select basic model.
- B** Select assembly option.
- KD** - Knock down
FO - Frame only
- C** Select trim color for painted surfaces. Refer to Finish Options on page 7. Trim color selection includes paint and upright insert (plastic component) colors. All colors are monochromatic except CF, CM, EX, MZ, and SX. For the exceptions, the plastic components for CF and CM paint are LG, EX paint receives BL plastic, MZ paint receives SA plastic and SX paint receives WG plastic.
- D** Select laminate color. Refer to Finish Options on page 7.
- E** Select key option.
- KA** - Key alike
KS - Key standard
NLC - No lock core

FlexStation® Components

Open Shelf

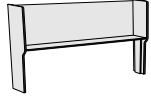

WOSFO

MODEL	W x H x D	MODEL NUMBER					Approx. Packaged Weight
		Basic Model	Assembly	Laminate Color	Trim Color	Key Option	
Open Shelf <ul style="list-style-type: none"> • Solid core construction with plastic laminate • Enamel finish on metal parts • Concealed vertical wire management • Secured to steel legs by concealed mounting brackets • Field installable to compatible FlexStation® worksurfaces • For use with fixed height workstations only • Overhead allows for 18-1/2" clearance above worksurface • Overall height is 34-1/4" • Cannot be mounted on tables with casters • Select size of overhead. Length of overhead must be identical to length of worksurface 	30 x 16-1/2 x 14-1/2"	WOS30	<input type="checkbox"/> <input type="checkbox"/>	<input type="checkbox"/> <input type="checkbox"/> <input type="checkbox"/>	<input type="checkbox"/> <input type="checkbox"/>	<input type="checkbox"/> <input type="checkbox"/>	49#
	36 x 16-1/2 x 14-1/2"	WOS36	<input type="checkbox"/> <input type="checkbox"/>	<input type="checkbox"/> <input type="checkbox"/> <input type="checkbox"/>	<input type="checkbox"/> <input type="checkbox"/>	<input type="checkbox"/> <input type="checkbox"/>	52#
	42 x 16-1/2 x 14-1/2"	WOS42	<input type="checkbox"/> <input type="checkbox"/>	<input type="checkbox"/> <input type="checkbox"/> <input type="checkbox"/>	<input type="checkbox"/> <input type="checkbox"/>	<input type="checkbox"/> <input type="checkbox"/>	54#
	48 x 16-1/2 x 14-1/2"	WOS48	<input type="checkbox"/> <input type="checkbox"/>	<input type="checkbox"/> <input type="checkbox"/> <input type="checkbox"/>	<input type="checkbox"/> <input type="checkbox"/>	<input type="checkbox"/> <input type="checkbox"/>	58#
	54 x 16-1/2 x 14-1/2"	WOS54	<input type="checkbox"/> <input type="checkbox"/>	<input type="checkbox"/> <input type="checkbox"/> <input type="checkbox"/>	<input type="checkbox"/> <input type="checkbox"/>	<input type="checkbox"/> <input type="checkbox"/>	62#
	60 x 16-1/2 x 14-1/2"	WOS60	<input type="checkbox"/> <input type="checkbox"/>	<input type="checkbox"/> <input type="checkbox"/> <input type="checkbox"/>	<input type="checkbox"/> <input type="checkbox"/>	<input type="checkbox"/> <input type="checkbox"/>	65#
	72 x 16-1/2 x 14-1/2"	WOS72	<input type="checkbox"/> <input type="checkbox"/>	<input type="checkbox"/> <input type="checkbox"/> <input type="checkbox"/>	<input type="checkbox"/> <input type="checkbox"/>	<input type="checkbox"/> <input type="checkbox"/>	71#
			A	B	C	D	E

HOW TO ORDER

Indicate the following information on order form:

1. Quantity of each item.
2. Model number, including options.
See "How To Build a Model Number".
3. Any special service required.

Note: • The indicates that a choice is required.

- The absence of the indicates that no choice is required.
- Alpha-numeric characters in place of indicates that no other alternatives are available.

HOW TO BUILD A MODEL NUMBER

A Select basic model.

B Select assembly option.

- KD** - Knock down (without wood sides)
FO - Frame only (metal shelf & hardware)

C Select laminate color.

Refer to Finish Options on page 7.

D Select trim color for painted surfaces.

Refer to Finish Options on page 7.

Trim color selection includes paint and upright insert (plastic component) colors. All colors are monochromatic except CF, CM, EX, MZ, and SX. For the exceptions, the plastic components for CF and CM paint are LG, EX paint receives BL plastic, MZ paint receives SA plastic and SX paint receives WG plastic.

F Select key option.

- KA** - Key alike
KS - Key standard
NLC - No lock core

FlexStation® Components

Privacy Screens

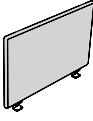
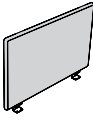
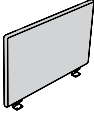
	MODEL	Features	W x H	MODEL NUMBER			Approx. Packaged Weight	
				Basic Model	Trim Color	Fabric Color		
 WZPRF	Basic Privacy Screen	<ul style="list-style-type: none"> 1" thick screen upholstered with tackable fabric Painted steel mounting brackets Screens available for all worksurfaces and transitional surfaces Field installable Provides seated privacy WZP60 has two 30" privacy screens with connector WZP72 has two 36" privacy screens with connector Corner (square and rectangular) screens come as a set with splice plate Available with manual height adjustable surfaces Provides 3/4" space between screen and worksurface for cables 	Basic	24 x 19"	WZP24	<input type="checkbox"/>	<input type="checkbox"/>	13#
			Basic	30 x 19"	WZP30	<input type="checkbox"/>	<input type="checkbox"/>	15#
			Basic	36 x 19"	WZP36	<input type="checkbox"/>	<input type="checkbox"/>	17#
			Basic	42 x 19"	WZP42	<input type="checkbox"/>	<input type="checkbox"/>	19#
			Basic	48 x 19"	WZP48	<input type="checkbox"/>	<input type="checkbox"/>	21#
			Basic	54 x 19"	WZP54	<input type="checkbox"/>	<input type="checkbox"/>	24#
			Basic	60 x 19"	WZP60	<input type="checkbox"/>	<input type="checkbox"/>	30#
			Basic	66 x 19"	WZP66	<input type="checkbox"/>	<input type="checkbox"/>	32#
			Basic	72 x 19"	WZP72	<input type="checkbox"/>	<input type="checkbox"/>	34#
			 WZPRF	Corner Privacy Screen	<ul style="list-style-type: none"> Features the same as Basic Privacy Screen Corner (square and rectangle) screens come as a set with splice plates To be used with transitional and stand-alone corner worksurfaces 	Corner (2 screens)	36 x 19"	WZPC2436
Corner (2 screens)	42 x 19"	WZPC2442				<input type="checkbox"/>	<input type="checkbox"/>	34#
Corner (2 screens)	48 x 19"	WZPC3048				<input type="checkbox"/>	<input type="checkbox"/>	40#
 WZPRF	Transtional Privacy Screen	<ul style="list-style-type: none"> Features the same as Basic Privacy Screen Corner (square and rectangle) screens come as a set with splice plates 	Rectangle (2 screens)	30 x 19"	WZPR3024	<input type="checkbox"/>	<input type="checkbox"/>	30#
			Square (2 screens)	24 x 19"	WZPS2424	<input type="checkbox"/>	<input type="checkbox"/>	26#
			Square (2 screens)	30 x 19"	WZPS3030	<input type="checkbox"/>	<input type="checkbox"/>	30#
			Triangle (1 screens)	30 x 19"	WZPT3030	<input type="checkbox"/>	<input type="checkbox"/>	30#
				A	B	C		

HOW TO ORDER

Indicate the following information on order form:

- Quantity of each item.
- Model number, including options.
See "How To Build a Model Number".
- Any special service required.

Note: • The indicates that a choice is required.

- The absence of the indicates that no choice is required.
- Alpha-numeric characters in place of indicates that no other alternatives are available.

HOW TO BUILD A MODEL NUMBER

- Select basic model.
- Select trim color.
Refer to Finish Options on page 7.
- Select fabric.

FlexStation® Components

Side Privacy Screens

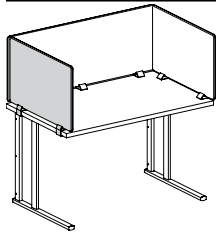
MODEL	Features	W x H	MODEL NUMBER			Approx. Packaged Weight
			Basic Model	Trim Color	Fabric Color	
 <p>WZPRF</p> <p>Basic Side Privacy Screen with Steel Brackets</p> <ul style="list-style-type: none"> • 1" thick screen upholstered with tackable fabric • Painted formed steel mounting brackets • End screens with steel brackets available for worksurfaces with or without grommets • Field installable • Provides seated privacy • Spans from front edge of worksurface to the front of the back privacy screen 	Basic	23 x 19"	WZPE24	<input type="checkbox"/> <input type="checkbox"/>	<input type="checkbox"/> <input type="checkbox"/> <input type="checkbox"/> <input type="checkbox"/>	13.0#
	Basic	29 x 19"	WZPE30	<input type="checkbox"/> <input type="checkbox"/>	<input type="checkbox"/> <input type="checkbox"/> <input type="checkbox"/> <input type="checkbox"/>	15.0#

A
 B
 C

HOW TO ORDER

Indicate the following information on order form:

1. Quantity of each item.
2. Model number, including options. See "How To Build a Model Number".
3. Any special service required.

Note: • The indicates that a choice is required.

- The absence of the indicates that no choice is required.
- Alpha-numeric characters in place of indicates that no other alternatives are available.

HOW TO BUILD A MODEL NUMBER

- A** Select basic model.
- B** Select trim color.
Refer to Finish Options on page 7.
- C** Select fabric.



FlexStation® Accessories

General Information



Tool Rail (PMTR)

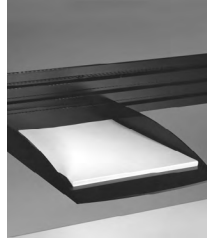

Paper Tray (PLL)



Vertical Storage (PVS)



Pencil Cup (PPC)

Features

Painted aluminum	•			
Plastic construction		•	•	•
Suspends from tool rail		•	•	•
Field installable	•	•	•	•

SPECIFICATIONS

Tool Rail

Aluminum extrusion tool rail, powder-coated finish. Attaches between overhead uprights. Consists of four slots to accept paper management components. To be used on WZUS, WZUF, WZUL, WUSS, BLCS, BLCL and BLCF models.

Paper Tray

Constructed of injection molded plastic. Tray measures 9-1/2" wide by 2" high by 14" deep and accommodates both letter and legal size documents. Includes three hooks to mount on tool rail.

Vertical Storage

Constructed of injection molded plastic. Holder measures 5" wide by 9" high and 10-1/2" deep. Includes two hooks to mount on tool rail.

Pencil Cup

Constructed of injection molded plastic. Cup

measures 4" wide by 3" high by 3-1/2" deep for storage of pens, pencils and highlighters. Includes one hook to mount on tool rail.

Diagonal Storage

Constructed of injection molded plastic. Storage tray consists of three diagonal slats with black dividers to sort files or papers. Tray measures 7" wide by 2-1/2" high by 12-1/2" deep and includes three hooks to mount on tool rail.

Telephone Caddy

Constructed of injection molded plastic. Caddy measures 8-1/2" wide by 2" high by 9-1/2" deep. Includes adjustable rail to accommodate a phone up to 10-3/4" deep. Includes three hooks to mount on tool rail.

Accessory Tray

Constructed of injection molded plastic. Holder measures 9-1/2" wide by 2" high by 10" deep and includes three hooks to mount to tool rail. Tray includes six compartments for storage of supplies.

FlexStation® Accessories

General Information



Center Drawer (3CMN)

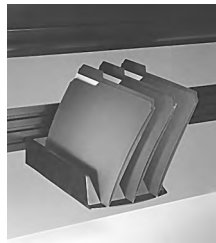

Diagonal Storage (PDS)

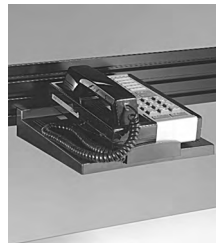

Telephone Caddy (PTC)

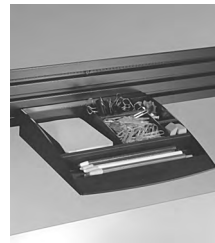

Accessory Tray (PAT)

Features

Plastic construction	•	•	•	•
Suspends from tool rail		•	•	•
Field installable	•	•		

FlexStation® Accessories

Paper Management

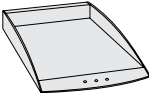
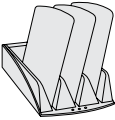
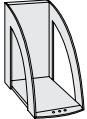
	MODEL	H x W x D	MODEL NUMBER		Approx. Packaged Weight
			Basic Model	Trim Color	
 HRDPT	Paper Tray <ul style="list-style-type: none"> • Plastic construction • Stores letter or legal size documents • Suspends from tool rail • Suitable for free-standing worksurface or overhead location 	2 x 9-1/2 x 14"	PLL	<input type="checkbox"/> <input type="checkbox"/>	1.0#
 HRDPT	Diagonal Storage <ul style="list-style-type: none"> • Plastic construction • Suspends only from tool rail • Suitable for free-standing worksurface or overhead location • Three slanted partitions per unit • Dividers in black only 	2-1/2 x 7 x 12-1/2"	PDS	<input type="checkbox"/> <input type="checkbox"/>	4.0#
 HRDPT	Vertical Storage <ul style="list-style-type: none"> • Injection molded plastic construction • Suspends only from tool rail • Suitable for free-standing worksurface or overhead location • Stores binders, phone books or periodicals 	9 x 5 x 10-1/2"	PVS	<input type="checkbox"/> <input type="checkbox"/>	1.0#
			A	B	

HOW TO ORDER

Indicate the following information on order form:

1. Quantity of each item.
2. Model number, including options.
See "How To Build a Model Number".
3. Any special service required.

Note: • The indicates that a choice is required.



- The absence of the indicates that no choice is required.
- Alpha-numeric characters in place of indicates that no other alternatives are available.

HOW TO BUILD A MODEL NUMBER

- A** Select basic model.
- B** Select trim color.
Refer to Finish Options on page 7.

FlexStation® Accessories

Paper Management

	MODEL	H x W x D	MODEL NUMBER		Approx. Packaged Weight
			Basic Model	Trim Color	
 HRDPT	Telephone Caddy <ul style="list-style-type: none"> • Plastic construction • Holds telephone up to 8-1/2" wide and 9-1/2" deep • Suspends from tool rail 	2 x 8-1/2 x 9-1/2"	PTC	<input type="checkbox"/> <input type="checkbox"/>	1.0#
 HRDPT	Accessory Tray <ul style="list-style-type: none"> • Injection molded plastic • Stores stamps, tape dispenser, post-it pads and paper clips • Suspends from tool rail 	2 x 9-1/2 x 10"	PAT	<input type="checkbox"/> <input type="checkbox"/>	6.0#
 HRDPT	Pencil Cup <ul style="list-style-type: none"> • Injection molded plastic • Suspends from tool rail 	4 x 4 x 3-1/2"	PPC	<input type="checkbox"/> <input type="checkbox"/>	1.0#

A

B

HOW TO ORDER

Indicate the following information on order form:

1. Quantity of each item.
2. Model number, including options.
See "How To Build a Model Number".
3. Any special service required.

Note: • The indicates that a choice is required.

- The absence of the indicates that no choice is required.
- Alpha-numeric characters in place of indicates that no other alternatives are available.

HOW TO BUILD A MODEL NUMBER

- A** Select basic model.
- B** Select trim color.
Refer to Finish Options on page 7.

FlexStation® Accessories

Center Drawer

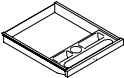
MODEL	W x D x H	MODEL NUMBER			Approx. Packaged Weight
		Basic Model	Trim Color	Key Option	
 <p>Center Drawer</p> <ul style="list-style-type: none"> Molded plastic compartment tray 	18 x 18 x 2-3/4"	3CMN	<input type="checkbox"/> <input type="checkbox"/>	<input type="checkbox"/> <input type="checkbox"/> <input type="checkbox"/>	11.0#

A **B** **C**

HRDPT

HOW TO ORDER

Indicate the following information on order form:

- Quantity of each item.
- Model number, including options.
See "How To Build a Model Number".
- Any special service required.

Note: • The indicates that a choice is required.
• The absence of the indicates that no choice is required.
• Alpha-numeric characters in place of indicates that no other alternatives are available.

HOW TO BUILD A MODEL NUMBER

- A** Select basic model.
- B** Select trim color.
Refer to Finish Options on page 7.

- C** Select key option.

KA - Key alike
KS - Key standard
NLC - No lock core

FlexStation® with Power

General Information

SPECIFICATIONS

UL Listed

The FlexStation® with Power System is listed to applicable UL standards and requirements by Underwriters Laboratories, Inc.

Two of the standards used to evaluate FlexStation® are UL/286 Office Furnishings and UL/723 Standard for Test for Surface Burning Characteristics of Building Materials.

The standard used to evaluate Power is UL 1363 Relocatable Power Taps.

FlexStation[®] with Power

General Information

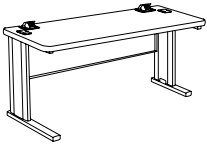

FlexStation® with Power

	D x W	MODEL NUMBER															
		Basic Model	Edge Style	P-Up Mod.	Ht.	W-Trgh.	Elct. Opt.	Frame Style	Trans. Legs	Grom.	Paint Clr.	Insrt. Clr.	Lam. Clr.	Edge Clr.	Grm. Clr.		P-Up Mod. Clr.
 WBWPF FlexStation® w/Power Worksurface	24 x 30"	WBWD2430	<input type="checkbox"/>	<input type="checkbox"/>	<input type="checkbox"/>	<input type="checkbox"/>	<input type="checkbox"/>	<input type="checkbox"/>	<input type="checkbox"/>	<input type="checkbox"/>	<input type="checkbox"/>	<input type="checkbox"/>	<input type="checkbox"/>	<input type="checkbox"/>	<input type="checkbox"/>	<input type="checkbox"/>	<input type="checkbox"/>
	24 x 36"	WBWD2436	<input type="checkbox"/>	<input type="checkbox"/>	<input type="checkbox"/>	<input type="checkbox"/>	<input type="checkbox"/>	<input type="checkbox"/>	<input type="checkbox"/>	<input type="checkbox"/>	<input type="checkbox"/>	<input type="checkbox"/>	<input type="checkbox"/>	<input type="checkbox"/>	<input type="checkbox"/>	<input type="checkbox"/>	<input type="checkbox"/>
	24 x 42"	WBWD2442	<input type="checkbox"/>	<input type="checkbox"/>	<input type="checkbox"/>	<input type="checkbox"/>	<input type="checkbox"/>	<input type="checkbox"/>	<input type="checkbox"/>	<input type="checkbox"/>	<input type="checkbox"/>	<input type="checkbox"/>	<input type="checkbox"/>	<input type="checkbox"/>	<input type="checkbox"/>	<input type="checkbox"/>	<input type="checkbox"/>
	24 x 48"	WBWD2448	<input type="checkbox"/>	<input type="checkbox"/>	<input type="checkbox"/>	<input type="checkbox"/>	<input type="checkbox"/>	<input type="checkbox"/>	<input type="checkbox"/>	<input type="checkbox"/>	<input type="checkbox"/>	<input type="checkbox"/>	<input type="checkbox"/>	<input type="checkbox"/>	<input type="checkbox"/>	<input type="checkbox"/>	<input type="checkbox"/>
	24 x 54"	WBWD2454	<input type="checkbox"/>	<input type="checkbox"/>	<input type="checkbox"/>	<input type="checkbox"/>	<input type="checkbox"/>	<input type="checkbox"/>	<input type="checkbox"/>	<input type="checkbox"/>	<input type="checkbox"/>	<input type="checkbox"/>	<input type="checkbox"/>	<input type="checkbox"/>	<input type="checkbox"/>	<input type="checkbox"/>	<input type="checkbox"/>
	30 x 30"	WBWD3030	<input type="checkbox"/>	<input type="checkbox"/>	<input type="checkbox"/>	<input type="checkbox"/>	<input type="checkbox"/>	<input type="checkbox"/>	<input type="checkbox"/>	<input type="checkbox"/>	<input type="checkbox"/>	<input type="checkbox"/>	<input type="checkbox"/>	<input type="checkbox"/>	<input type="checkbox"/>	<input type="checkbox"/>	<input type="checkbox"/>
	30 x 36"	WBWD3036	<input type="checkbox"/>	<input type="checkbox"/>	<input type="checkbox"/>	<input type="checkbox"/>	<input type="checkbox"/>	<input type="checkbox"/>	<input type="checkbox"/>	<input type="checkbox"/>	<input type="checkbox"/>	<input type="checkbox"/>	<input type="checkbox"/>	<input type="checkbox"/>	<input type="checkbox"/>	<input type="checkbox"/>	<input type="checkbox"/>
	30 x 42"	WBWD3042	<input type="checkbox"/>	<input type="checkbox"/>	<input type="checkbox"/>	<input type="checkbox"/>	<input type="checkbox"/>	<input type="checkbox"/>	<input type="checkbox"/>	<input type="checkbox"/>	<input type="checkbox"/>	<input type="checkbox"/>	<input type="checkbox"/>	<input type="checkbox"/>	<input type="checkbox"/>	<input type="checkbox"/>	<input type="checkbox"/>
	30 x 48"	WBWD3048	<input type="checkbox"/>	<input type="checkbox"/>	<input type="checkbox"/>	<input type="checkbox"/>	<input type="checkbox"/>	<input type="checkbox"/>	<input type="checkbox"/>	<input type="checkbox"/>	<input type="checkbox"/>	<input type="checkbox"/>	<input type="checkbox"/>	<input type="checkbox"/>	<input type="checkbox"/>	<input type="checkbox"/>	<input type="checkbox"/>
30 x 54"	WBWD3054	<input type="checkbox"/>	<input type="checkbox"/>	<input type="checkbox"/>	<input type="checkbox"/>	<input type="checkbox"/>	<input type="checkbox"/>	<input type="checkbox"/>	<input type="checkbox"/>	<input type="checkbox"/>	<input type="checkbox"/>	<input type="checkbox"/>	<input type="checkbox"/>	<input type="checkbox"/>	<input type="checkbox"/>	<input type="checkbox"/>	
 WBWPF FlexStation® w/Power Worksurface	24 x 60"	WBWD2460	<input type="checkbox"/>	<input type="checkbox"/>	<input type="checkbox"/>	<input type="checkbox"/>	<input type="checkbox"/>	<input type="checkbox"/>	<input type="checkbox"/>	<input type="checkbox"/>	<input type="checkbox"/>	<input type="checkbox"/>	<input type="checkbox"/>	<input type="checkbox"/>	<input type="checkbox"/>	<input type="checkbox"/>	<input type="checkbox"/>
	24 x 66"	WBWD2466	<input type="checkbox"/>	<input type="checkbox"/>	<input type="checkbox"/>	<input type="checkbox"/>	<input type="checkbox"/>	<input type="checkbox"/>	<input type="checkbox"/>	<input type="checkbox"/>	<input type="checkbox"/>	<input type="checkbox"/>	<input type="checkbox"/>	<input type="checkbox"/>	<input type="checkbox"/>	<input type="checkbox"/>	<input type="checkbox"/>
	24 x 72"	WBWD2472	<input type="checkbox"/>	<input type="checkbox"/>	<input type="checkbox"/>	<input type="checkbox"/>	<input type="checkbox"/>	<input type="checkbox"/>	<input type="checkbox"/>	<input type="checkbox"/>	<input type="checkbox"/>	<input type="checkbox"/>	<input type="checkbox"/>	<input type="checkbox"/>	<input type="checkbox"/>	<input type="checkbox"/>	<input type="checkbox"/>
	30 x 60"	WBWD3060	<input type="checkbox"/>	<input type="checkbox"/>	<input type="checkbox"/>	<input type="checkbox"/>	<input type="checkbox"/>	<input type="checkbox"/>	<input type="checkbox"/>	<input type="checkbox"/>	<input type="checkbox"/>	<input type="checkbox"/>	<input type="checkbox"/>	<input type="checkbox"/>	<input type="checkbox"/>	<input type="checkbox"/>	<input type="checkbox"/>
	30 x 66"	WBWD3066	<input type="checkbox"/>	<input type="checkbox"/>	<input type="checkbox"/>	<input type="checkbox"/>	<input type="checkbox"/>	<input type="checkbox"/>	<input type="checkbox"/>	<input type="checkbox"/>	<input type="checkbox"/>	<input type="checkbox"/>	<input type="checkbox"/>	<input type="checkbox"/>	<input type="checkbox"/>	<input type="checkbox"/>	<input type="checkbox"/>
	30 x 72"	WBWD3072	<input type="checkbox"/>	<input type="checkbox"/>	<input type="checkbox"/>	<input type="checkbox"/>	<input type="checkbox"/>	<input type="checkbox"/>	<input type="checkbox"/>	<input type="checkbox"/>	<input type="checkbox"/>	<input type="checkbox"/>	<input type="checkbox"/>	<input type="checkbox"/>	<input type="checkbox"/>	<input type="checkbox"/>	<input type="checkbox"/>
			A	B	C	D	E	F	G	H	I	J	K	L	M	N	O

HOW TO ORDER

Indicate the following information on order form:

- Quantity of each item.
- Model number, including options.
See "How To Build a Model Number".
- Any special service required.

Note: • The indicates that a choice is required.

- The absence of the indicates that no choice is required.
- Alpha-numeric characters in place of indicates that no other alternatives are available.

HOW TO BUILD A MODEL NUMBER

- A** Select basic model.

- B** Select edge style.
BN - Flat vinyl T-edge
74P - 74P edge

- C** Select PowerUp® module location.
PUN - No module
PUL - Left module
PUR - Right module
PUC - Center module
PUB - Both left and right modules

- PUB option only available on 60", 66" and 72" wide worksurfaces. PUC option: Overhead storage is not available on 66" or 72" basic FlexStation® worksurfaces with center location PowerUp® modules.
- D** Select height.
7 - 27" high
9 - 29" high

- E** Select wire trough.
NT - No wire trough
WT - Wire trough
 Available in black only.

- F** Select electrical option.
NP - No power
T6 - T6 power
 If T6 power is specified, receptacles, jumpers and infeeds are to be specified separately.

- G** Select frame style.
WB - w/ Beam
WM - w/ Modesty panel
WF - w/ Full modesty panel
 w/ Full modesty panel (available on 29" high only)

- H** Select location and type of leg.
TS - Standard legs
TL - Transition leg (left)
TR - Transition leg (right)
TB - Transition leg (both)

- I** Select grommet option.
 Grommets are required for overhead cabinet.
OGN - No worksurface grommet
OGY - Yes worksurface grommet
 Grommets can be used for wire pass-through.

- J** Select paint color.
 Refer to Finish Options on page 7.

- K** Select insert color.
 Refer to Finish Options on page 7.
 Insert color also includes wire trough (WT) if selected.

- L** Select laminate surface.
 Refer to Finish Options on page 7.

- M** Select edge color.
 Refer to Finish Options on page 7.
 Edge color offerings are based on edge style selections.

- N** Select grommet color.
 Refer to Finish Options on page 7.

- O** Select PowerUp® module color.
 Refer to Finish Options on page 7.

FlexStation® with Power

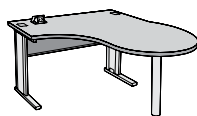
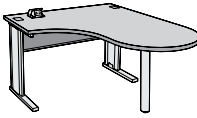
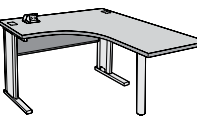
	D x W x L	MODEL NUMBER																
		Basic Model	Edge Style	Dr.	P-Up Mod.	Ht.	W-Trgh.	Elct. Opt.	Frame Style	Leg	Grom.	Paint Clr.	Insrt. Clr.	Lam. Clr.	Edge Clr.	Grm. Clr.	P-Up Mod. Clr.	
 <p>WZWPF "P" Shaped Peninsula Worksurface</p> <ul style="list-style-type: none"> • Guest modesty panel (WZMP) may be ordered 	24 x 48 x 60"	WZPTD244860	<input type="checkbox"/>	<input type="checkbox"/>	<input type="checkbox"/>	9	<input type="checkbox"/>	<input type="checkbox"/>	<input type="checkbox"/>	<input type="checkbox"/>	<input type="checkbox"/>	<input type="checkbox"/>	<input type="checkbox"/>	<input type="checkbox"/>	<input type="checkbox"/>	<input type="checkbox"/>	<input type="checkbox"/>	
	24 x 48 x 72"	WZPTD244872	<input type="checkbox"/>	<input type="checkbox"/>	<input type="checkbox"/>	9	<input type="checkbox"/>	<input type="checkbox"/>	<input type="checkbox"/>	<input type="checkbox"/>	<input type="checkbox"/>	<input type="checkbox"/>	<input type="checkbox"/>	<input type="checkbox"/>	<input type="checkbox"/>	<input type="checkbox"/>	<input type="checkbox"/>	
	30 x 48 x 72"	WZPTD304872	<input type="checkbox"/>	<input type="checkbox"/>	<input type="checkbox"/>	9	<input type="checkbox"/>	<input type="checkbox"/>	<input type="checkbox"/>	<input type="checkbox"/>	<input type="checkbox"/>	<input type="checkbox"/>	<input type="checkbox"/>	<input type="checkbox"/>	<input type="checkbox"/>	<input type="checkbox"/>	<input type="checkbox"/>	
 <p>WZWPF Piano Peninsula Worksurface</p> <ul style="list-style-type: none"> • Guest modesty panel (WZMP) may be ordered 	24 x 48 x 60"	WZPPD244860	<input type="checkbox"/>	<input type="checkbox"/>	<input type="checkbox"/>	9	<input type="checkbox"/>	<input type="checkbox"/>	<input type="checkbox"/>	<input type="checkbox"/>	<input type="checkbox"/>	<input type="checkbox"/>	<input type="checkbox"/>	<input type="checkbox"/>	<input type="checkbox"/>	<input type="checkbox"/>	<input type="checkbox"/>	
	24 x 48 x 72"	WZPPD244872	<input type="checkbox"/>	<input type="checkbox"/>	<input type="checkbox"/>	9	<input type="checkbox"/>	<input type="checkbox"/>	<input type="checkbox"/>	<input type="checkbox"/>	<input type="checkbox"/>	<input type="checkbox"/>	<input type="checkbox"/>	<input type="checkbox"/>	<input type="checkbox"/>	<input type="checkbox"/>	<input type="checkbox"/>	
	30 x 48 x 72"	WZPPD304872	<input type="checkbox"/>	<input type="checkbox"/>	<input type="checkbox"/>	9	<input type="checkbox"/>	<input type="checkbox"/>	<input type="checkbox"/>	<input type="checkbox"/>	<input type="checkbox"/>	<input type="checkbox"/>	<input type="checkbox"/>	<input type="checkbox"/>	<input type="checkbox"/>	<input type="checkbox"/>	<input type="checkbox"/>	
 <p>WZWPF Square Shoe Worksurface</p> <ul style="list-style-type: none"> • Guest modesty panel (WZMP) may be ordered 	24 x 48 x 60"	WZSSD244860	<input type="checkbox"/>	<input type="checkbox"/>	<input type="checkbox"/>	9	<input type="checkbox"/>	<input type="checkbox"/>	<input type="checkbox"/>	<input type="checkbox"/>	<input type="checkbox"/>	<input type="checkbox"/>	<input type="checkbox"/>	<input type="checkbox"/>	<input type="checkbox"/>	<input type="checkbox"/>	<input type="checkbox"/>	
	24 x 48 x 66"	WZSSD244866	<input type="checkbox"/>	<input type="checkbox"/>	<input type="checkbox"/>	9	<input type="checkbox"/>	<input type="checkbox"/>	<input type="checkbox"/>	<input type="checkbox"/>	<input type="checkbox"/>	<input type="checkbox"/>	<input type="checkbox"/>	<input type="checkbox"/>	<input type="checkbox"/>	<input type="checkbox"/>	<input type="checkbox"/>	
	24 x 48 x 72"	WZSSD244872	<input type="checkbox"/>	<input type="checkbox"/>	<input type="checkbox"/>	9	<input type="checkbox"/>	<input type="checkbox"/>	<input type="checkbox"/>	<input type="checkbox"/>	<input type="checkbox"/>	<input type="checkbox"/>	<input type="checkbox"/>	<input type="checkbox"/>	<input type="checkbox"/>	<input type="checkbox"/>	<input type="checkbox"/>	
	24 x 48 x 84"	WZSSD244884	<input type="checkbox"/>	<input type="checkbox"/>	<input type="checkbox"/>	9	<input type="checkbox"/>	<input type="checkbox"/>	<input type="checkbox"/>	<input type="checkbox"/>	<input type="checkbox"/>	<input type="checkbox"/>	<input type="checkbox"/>	<input type="checkbox"/>	<input type="checkbox"/>	<input type="checkbox"/>	<input type="checkbox"/>	
	30 x 48 x 66"	WZSSD304866	<input type="checkbox"/>	<input type="checkbox"/>	<input type="checkbox"/>	9	<input type="checkbox"/>	<input type="checkbox"/>	<input type="checkbox"/>	<input type="checkbox"/>	<input type="checkbox"/>	<input type="checkbox"/>	<input type="checkbox"/>	<input type="checkbox"/>	<input type="checkbox"/>	<input type="checkbox"/>	<input type="checkbox"/>	
	30 x 48 x 72"	WZSSD304872	<input type="checkbox"/>	<input type="checkbox"/>	<input type="checkbox"/>	9	<input type="checkbox"/>	<input type="checkbox"/>	<input type="checkbox"/>	<input type="checkbox"/>	<input type="checkbox"/>	<input type="checkbox"/>	<input type="checkbox"/>	<input type="checkbox"/>	<input type="checkbox"/>	<input type="checkbox"/>	<input type="checkbox"/>	
	30 x 48 x 84"	WZSSD304884	<input type="checkbox"/>	<input type="checkbox"/>	<input type="checkbox"/>	9	<input type="checkbox"/>	<input type="checkbox"/>	<input type="checkbox"/>	<input type="checkbox"/>	<input type="checkbox"/>	<input type="checkbox"/>	<input type="checkbox"/>	<input type="checkbox"/>	<input type="checkbox"/>	<input type="checkbox"/>	<input type="checkbox"/>	
			A	B	C	D	E	F	G	H	I	J	K	L	M	N	O	P

HOW TO ORDER

Indicate the following information on order form:

- Quantity of each item.
- Model number, including options.
See "How To Build a Model Number".
- Any special service required.



Note: • The indicates that a choice is required.
• The absence of the indicates that no choice is required.
• Alpha-numeric characters in place of indicates that no other alternatives are available.

HOW TO BUILD A MODEL NUMBER

- A** Select basic model.
- B** Select edge style.
BN - Flat vinyl T-edge
74P - 74P edge
- C** Select surface direction.
L - Left
R - Right
- D** Select PowerUp® module location.
PUN - No module
PUL - Left module
PUR - Right module
PUC - Center module
- E** Select height.
9 - 29" high
- F** Select wire trough.
NT - No wire trough
WT - Wire trough
 Available in black only.
- G** Select electrical option.
NP - No power
T6 - T6 power
- H** Select frame style.
WB - w/ Beam
WM - w/ Modesty panel
WF - w/ Full modesty panel
 w/ Full modesty panel (available on 29" high only).
- I** Select location and type of leg.
TS - Standard legs
TL - Transition leg (left)
TR - Transition leg (right)
TB - Transition leg (both)
- J** Select grommet option.
 Grommets are required for overhead cabinet.
OGN - No worksurface grommet
OGY - Yes worksurface grommet
 Grommets can be used for wire pass-through.
- K** Select paint color.
 Refer to Finish Options on page 7.
- L** Select insert color.
 Refer to Finish Options on page 7.
 Insert color also includes wire trough (WT) if selected.
- M** Select laminate surface.
 Refer to Finish Options on page 7.
- N** Select edge color.
 Refer to Finish Options on page 7.
 Edge color offerings are based on edge style selections.
- O** Select grommet color.
 Refer to Finish Options on page 7.
- P** Select PowerUp® module color.
 Refer to Finish Options on page 7.

FlexStation® with Power

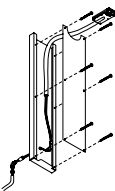
Electrical

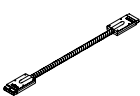
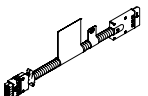
MODEL	MODEL NUMBER		Approx. Packaged Weight
	Basic Model	Trim Color	
 <p>Floor Infeed (6-Circuit Pre-wired) 6-2-2</p> <ul style="list-style-type: none"> • Provides power from fixed floor or wall sources to table distribution system • Select height to match leg height. Example: 27", 29" or 42" • Infeed distributes power in one direction only. Specify two infeeds for middle of row applications so power travels in both directions 	WZ.T6Pl.27	<input type="checkbox"/>	5.0#
	WZ.T6Pl.29	<input type="checkbox"/>	5.0#
	WZ.T6Pl.42	<input type="checkbox"/>	6.0#
HRDPT			
 <p>Duplex Receptacle -10-Wire System 6-2-2</p> <ul style="list-style-type: none"> • Convenience circuits share a neutral and ground wire • The 1, 2 or 3 in the basic model number denotes the circuit • Black only 	WZ.T6RECP.1		0.2#
	WZ.T6RECP.2		0.2#
	WZ.T6RECP.3		0.2#
HRDPT			
 <p>Isolated Receptacle - 10-Wire System 6-2-2</p> <ul style="list-style-type: none"> • Dedicated circuit has its own neutral and ground wire • Orange only 	WZ.T6RECP.4I		0.2#
	WZ.T6RECP.5I		0.2#
	WZ.T6RECP.6I		0.2#
HRDPT			
 <p>10-Wire Table-to-Table Connector 6-2-2</p> <ul style="list-style-type: none"> • Connects the 10-wire power system of two adjoining tables • 17-3/4" long • Includes steel wireway and splice plate • Black only 	WZ.T6SC18		0.5#
HRDPT			
 <p>8-Wire to 10-Wire Adaptor</p> <ul style="list-style-type: none"> • 30" long 	47.0568.30		1.0#
HRDPT			

A

B

HOW TO ORDER

Indicate the following information on order form:

1. Quantity of each item.
2. Model number, including options. See "How To Build a Model Number".
3. Any special service required.

Note: • The indicates that a choice is required.

- The absence of the indicates that no choice is required.
- Alpha-numeric characters in place of indicates that no other alternatives are available.

HOW TO BUILD A MODEL NUMBER

- A** Select basic model.
- B** Select trim color.
Refer to Finish Options on page 7.

FlexStation® with Shared Leg

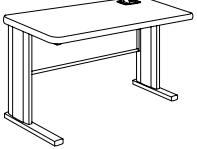
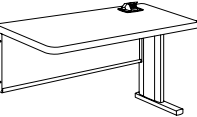
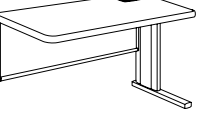
	D x W	MODEL NUMBER												
		Basic Model	Edge Style	PowerUp Module	W-Trgh	Elct Opt	Frame Style	Wrksrf. Grom.	Paint Color	Insert Color	Lam. Color	Edge Color	Grom. Color	PowerUp Module Color
 <p>WZSLF 24" Starter</p>	24 x 30"	WBSL2430S	<input type="checkbox"/>	<input type="checkbox"/>	<input type="checkbox"/>	<input type="checkbox"/>	<input type="checkbox"/>	<input type="checkbox"/>	<input type="checkbox"/>					
	24 x 36"	WBSL2436S	<input type="checkbox"/>	<input type="checkbox"/>	<input type="checkbox"/>	<input type="checkbox"/>	<input type="checkbox"/>	<input type="checkbox"/>	<input type="checkbox"/>					
	24 x 42"	WBSL2442S	<input type="checkbox"/>	<input type="checkbox"/>	<input type="checkbox"/>	<input type="checkbox"/>	<input type="checkbox"/>	<input type="checkbox"/>	<input type="checkbox"/>					
	24 x 48"	WBSL2448S	<input type="checkbox"/>	<input type="checkbox"/>	<input type="checkbox"/>	<input type="checkbox"/>	<input type="checkbox"/>	<input type="checkbox"/>	<input type="checkbox"/>					
	24 x 54"	WBSL2454S	<input type="checkbox"/>	<input type="checkbox"/>	<input type="checkbox"/>	<input type="checkbox"/>	<input type="checkbox"/>	<input type="checkbox"/>	<input type="checkbox"/>					
	24 x 60"	WBSL2460S	<input type="checkbox"/>	<input type="checkbox"/>	<input type="checkbox"/>	<input type="checkbox"/>	<input type="checkbox"/>	<input type="checkbox"/>	<input type="checkbox"/>					
	24 x 66"	WBSL2466S	<input type="checkbox"/>	<input type="checkbox"/>	<input type="checkbox"/>	<input type="checkbox"/>	<input type="checkbox"/>	<input type="checkbox"/>	<input type="checkbox"/>					
 <p>WZSLF 24" Adder</p>	24 x 30"	WBSL2430A	<input type="checkbox"/>	<input type="checkbox"/>	<input type="checkbox"/>	<input type="checkbox"/>	<input type="checkbox"/>	<input type="checkbox"/>	<input type="checkbox"/>					
	24 x 36"	WBSL2436A	<input type="checkbox"/>	<input type="checkbox"/>	<input type="checkbox"/>	<input type="checkbox"/>	<input type="checkbox"/>	<input type="checkbox"/>	<input type="checkbox"/>					
	24 x 42"	WBSL2442A	<input type="checkbox"/>	<input type="checkbox"/>	<input type="checkbox"/>	<input type="checkbox"/>	<input type="checkbox"/>	<input type="checkbox"/>	<input type="checkbox"/>					
	24 x 48"	WBSL2448A	<input type="checkbox"/>	<input type="checkbox"/>	<input type="checkbox"/>	<input type="checkbox"/>	<input type="checkbox"/>	<input type="checkbox"/>	<input type="checkbox"/>					
	24 x 54"	WBSL2454A	<input type="checkbox"/>	<input type="checkbox"/>	<input type="checkbox"/>	<input type="checkbox"/>	<input type="checkbox"/>	<input type="checkbox"/>	<input type="checkbox"/>					
	24 x 60"	WBSL2460A	<input type="checkbox"/>	<input type="checkbox"/>	<input type="checkbox"/>	<input type="checkbox"/>	<input type="checkbox"/>	<input type="checkbox"/>	<input type="checkbox"/>					
	24 x 66"	WBSL2466A	<input type="checkbox"/>	<input type="checkbox"/>	<input type="checkbox"/>	<input type="checkbox"/>	<input type="checkbox"/>	<input type="checkbox"/>	<input type="checkbox"/>					
24 x 72"	WBSL2472A	<input type="checkbox"/>	<input type="checkbox"/>	<input type="checkbox"/>	<input type="checkbox"/>	<input type="checkbox"/>	<input type="checkbox"/>	<input type="checkbox"/>						
 <p>WZSLF 24" Finisher</p>	24 x 30"	WBSL2430F	<input type="checkbox"/>	<input type="checkbox"/>	<input type="checkbox"/>	<input type="checkbox"/>	<input type="checkbox"/>	<input type="checkbox"/>	<input type="checkbox"/>					
	24 x 36"	WBSL2436F	<input type="checkbox"/>	<input type="checkbox"/>	<input type="checkbox"/>	<input type="checkbox"/>	<input type="checkbox"/>	<input type="checkbox"/>	<input type="checkbox"/>					
	24 x 42"	WBSL2442F	<input type="checkbox"/>	<input type="checkbox"/>	<input type="checkbox"/>	<input type="checkbox"/>	<input type="checkbox"/>	<input type="checkbox"/>	<input type="checkbox"/>					
	24 x 48"	WBSL2448F	<input type="checkbox"/>	<input type="checkbox"/>	<input type="checkbox"/>	<input type="checkbox"/>	<input type="checkbox"/>	<input type="checkbox"/>	<input type="checkbox"/>					
	24 x 54"	WBSL2454F	<input type="checkbox"/>	<input type="checkbox"/>	<input type="checkbox"/>	<input type="checkbox"/>	<input type="checkbox"/>	<input type="checkbox"/>	<input type="checkbox"/>					
	24 x 60"	WBSL2460F	<input type="checkbox"/>	<input type="checkbox"/>	<input type="checkbox"/>	<input type="checkbox"/>	<input type="checkbox"/>	<input type="checkbox"/>	<input type="checkbox"/>					
	24 x 66"	WBSL2466F	<input type="checkbox"/>	<input type="checkbox"/>	<input type="checkbox"/>	<input type="checkbox"/>	<input type="checkbox"/>	<input type="checkbox"/>	<input type="checkbox"/>					
24 x 72"	WBSL2472F	<input type="checkbox"/>	<input type="checkbox"/>	<input type="checkbox"/>	<input type="checkbox"/>	<input type="checkbox"/>	<input type="checkbox"/>	<input type="checkbox"/>						

A **B** **C** **D** **E** **F** **G** **H** **I** **J** **K** **L** **M**

HOW TO ORDER

Indicate the following information on order form:

- Quantity of each item.
- Model number, including options.
See "How To Build a Model Number".
- Any special service required.

- Note:
- The indicates that a choice is required.
 - The absence of the indicates that no choice is required.
 - Alpha-numeric characters in place of indicates that no other alternatives are available.

HOW TO BUILD A MODEL NUMBER

- A** Select basic model.
- B** Select edge style.
74P - 74P edge
- C** Select PowerUp® module location.
PUN - No module
PUL - Left module
PUR - Right module
PUC - Center module
PUB - Both left and right modules
PUB option only available on 60", 66" and 72" wide worksurfaces.
- D** Select wire trough.
NT - No wire trough
WT - Wire trough
Available in black only.
- E** Select electrical option.
NP - No power
T6 - T6 power
If T6 power is specified, receptacles, jumpers and infeeds are to be specified separately.
- F** Select frame style.
WM - w/ Modesty panel
WF - w/ Full modesty panel
- G** Select grommet option.
Overhead cabinet can NOT be ordered.
OGN - No worksurface grommet
OGY - Yes worksurface grommet
Grommets can be used for wire pass-through.
- H** Select paint color.
Refer to Finish Options on page 7.
- I** Select insert color.
Refer to Finish Options on page 7.
- J** Select laminate color.
Refer to Finish Options on page 7.
- K** Select edge color.
Refer to Finish Options on page 7.
Edge color offerings are based on edge style selections.
- L** Select grommet color.
Refer to Finish Options on page 7.
- M** Select PowerUp® module color.
Refer to Finish Options on page 7.

FlexStation® with Shared Leg

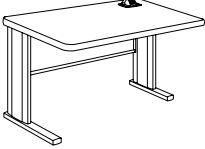
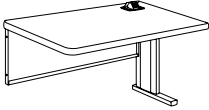
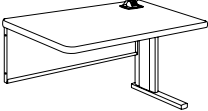
		MODEL NUMBER													
D x W		Basic Model	Edge Style	PowerUp Module	W-Trgh	Power Option	Frame Style	Wrksrf. Grom.	Paint Color	Insert Color	Lam. Color	Edge Color	Grom. Color	PowerUp Module Color	
 WZSLF 30" Starter	30 x 30"	WBSL3030S	<input type="checkbox"/>	<input type="checkbox"/>	<input type="checkbox"/>	<input type="checkbox"/>	<input type="checkbox"/>	<input type="checkbox"/>	<input type="checkbox"/>	<input type="checkbox"/>	<input type="checkbox"/>	<input type="checkbox"/>	<input type="checkbox"/>	<input type="checkbox"/>	
	30 x 36"	WBSL3036S	<input type="checkbox"/>	<input type="checkbox"/>	<input type="checkbox"/>	<input type="checkbox"/>	<input type="checkbox"/>	<input type="checkbox"/>	<input type="checkbox"/>	<input type="checkbox"/>	<input type="checkbox"/>	<input type="checkbox"/>	<input type="checkbox"/>	<input type="checkbox"/>	
	30 x 42"	WBSL3042S	<input type="checkbox"/>	<input type="checkbox"/>	<input type="checkbox"/>	<input type="checkbox"/>	<input type="checkbox"/>	<input type="checkbox"/>	<input type="checkbox"/>	<input type="checkbox"/>	<input type="checkbox"/>	<input type="checkbox"/>	<input type="checkbox"/>	<input type="checkbox"/>	
	30 x 48"	WBSL3048S	<input type="checkbox"/>	<input type="checkbox"/>	<input type="checkbox"/>	<input type="checkbox"/>	<input type="checkbox"/>	<input type="checkbox"/>	<input type="checkbox"/>	<input type="checkbox"/>	<input type="checkbox"/>	<input type="checkbox"/>	<input type="checkbox"/>	<input type="checkbox"/>	
	30 x 54"	WBSL3054S	<input type="checkbox"/>	<input type="checkbox"/>	<input type="checkbox"/>	<input type="checkbox"/>	<input type="checkbox"/>	<input type="checkbox"/>	<input type="checkbox"/>	<input type="checkbox"/>	<input type="checkbox"/>	<input type="checkbox"/>	<input type="checkbox"/>	<input type="checkbox"/>	
	30 x 60"	WBSL3060S	<input type="checkbox"/>	<input type="checkbox"/>	<input type="checkbox"/>	<input type="checkbox"/>	<input type="checkbox"/>	<input type="checkbox"/>	<input type="checkbox"/>	<input type="checkbox"/>	<input type="checkbox"/>	<input type="checkbox"/>	<input type="checkbox"/>	<input type="checkbox"/>	
	30 x 66"	WBSL3066S	<input type="checkbox"/>	<input type="checkbox"/>	<input type="checkbox"/>	<input type="checkbox"/>	<input type="checkbox"/>	<input type="checkbox"/>	<input type="checkbox"/>	<input type="checkbox"/>	<input type="checkbox"/>	<input type="checkbox"/>	<input type="checkbox"/>	<input type="checkbox"/>	
30 x 72"	WBSL3072S	<input type="checkbox"/>	<input type="checkbox"/>	<input type="checkbox"/>	<input type="checkbox"/>	<input type="checkbox"/>	<input type="checkbox"/>	<input type="checkbox"/>	<input type="checkbox"/>	<input type="checkbox"/>	<input type="checkbox"/>	<input type="checkbox"/>	<input type="checkbox"/>		
 WZSLF 30" Adder	30 x 30"	WBSL3030A	<input type="checkbox"/>	<input type="checkbox"/>	<input type="checkbox"/>	<input type="checkbox"/>	<input type="checkbox"/>	<input type="checkbox"/>	<input type="checkbox"/>	<input type="checkbox"/>	<input type="checkbox"/>	<input type="checkbox"/>	<input type="checkbox"/>	<input type="checkbox"/>	
	30 x 36"	WBSL3036A	<input type="checkbox"/>	<input type="checkbox"/>	<input type="checkbox"/>	<input type="checkbox"/>	<input type="checkbox"/>	<input type="checkbox"/>	<input type="checkbox"/>	<input type="checkbox"/>	<input type="checkbox"/>	<input type="checkbox"/>	<input type="checkbox"/>	<input type="checkbox"/>	
	30 x 42"	WBSL3042A	<input type="checkbox"/>	<input type="checkbox"/>	<input type="checkbox"/>	<input type="checkbox"/>	<input type="checkbox"/>	<input type="checkbox"/>	<input type="checkbox"/>	<input type="checkbox"/>	<input type="checkbox"/>	<input type="checkbox"/>	<input type="checkbox"/>	<input type="checkbox"/>	
	30 x 48"	WBSL3048A	<input type="checkbox"/>	<input type="checkbox"/>	<input type="checkbox"/>	<input type="checkbox"/>	<input type="checkbox"/>	<input type="checkbox"/>	<input type="checkbox"/>	<input type="checkbox"/>	<input type="checkbox"/>	<input type="checkbox"/>	<input type="checkbox"/>	<input type="checkbox"/>	
	30 x 54"	WBSL3054A	<input type="checkbox"/>	<input type="checkbox"/>	<input type="checkbox"/>	<input type="checkbox"/>	<input type="checkbox"/>	<input type="checkbox"/>	<input type="checkbox"/>	<input type="checkbox"/>	<input type="checkbox"/>	<input type="checkbox"/>	<input type="checkbox"/>	<input type="checkbox"/>	
	30 x 60"	WBSL3060A	<input type="checkbox"/>	<input type="checkbox"/>	<input type="checkbox"/>	<input type="checkbox"/>	<input type="checkbox"/>	<input type="checkbox"/>	<input type="checkbox"/>	<input type="checkbox"/>	<input type="checkbox"/>	<input type="checkbox"/>	<input type="checkbox"/>	<input type="checkbox"/>	
	30 x 66"	WBSL3066A	<input type="checkbox"/>	<input type="checkbox"/>	<input type="checkbox"/>	<input type="checkbox"/>	<input type="checkbox"/>	<input type="checkbox"/>	<input type="checkbox"/>	<input type="checkbox"/>	<input type="checkbox"/>	<input type="checkbox"/>	<input type="checkbox"/>	<input type="checkbox"/>	
30 x 72"	WBSL3072A	<input type="checkbox"/>	<input type="checkbox"/>	<input type="checkbox"/>	<input type="checkbox"/>	<input type="checkbox"/>	<input type="checkbox"/>	<input type="checkbox"/>	<input type="checkbox"/>	<input type="checkbox"/>	<input type="checkbox"/>	<input type="checkbox"/>	<input type="checkbox"/>		
 WZSLF 30" Finisher	30 x 30"	WBSL3030F	<input type="checkbox"/>	<input type="checkbox"/>	<input type="checkbox"/>	<input type="checkbox"/>	<input type="checkbox"/>	<input type="checkbox"/>	<input type="checkbox"/>	<input type="checkbox"/>	<input type="checkbox"/>	<input type="checkbox"/>	<input type="checkbox"/>	<input type="checkbox"/>	
	30 x 36"	WBSL3036F	<input type="checkbox"/>	<input type="checkbox"/>	<input type="checkbox"/>	<input type="checkbox"/>	<input type="checkbox"/>	<input type="checkbox"/>	<input type="checkbox"/>	<input type="checkbox"/>	<input type="checkbox"/>	<input type="checkbox"/>	<input type="checkbox"/>	<input type="checkbox"/>	
	30 x 42"	WBSL3042F	<input type="checkbox"/>	<input type="checkbox"/>	<input type="checkbox"/>	<input type="checkbox"/>	<input type="checkbox"/>	<input type="checkbox"/>	<input type="checkbox"/>	<input type="checkbox"/>	<input type="checkbox"/>	<input type="checkbox"/>	<input type="checkbox"/>	<input type="checkbox"/>	
	30 x 48"	WBSL3048F	<input type="checkbox"/>	<input type="checkbox"/>	<input type="checkbox"/>	<input type="checkbox"/>	<input type="checkbox"/>	<input type="checkbox"/>	<input type="checkbox"/>	<input type="checkbox"/>	<input type="checkbox"/>	<input type="checkbox"/>	<input type="checkbox"/>	<input type="checkbox"/>	
	30 x 54"	WBSL3054F	<input type="checkbox"/>	<input type="checkbox"/>	<input type="checkbox"/>	<input type="checkbox"/>	<input type="checkbox"/>	<input type="checkbox"/>	<input type="checkbox"/>	<input type="checkbox"/>	<input type="checkbox"/>	<input type="checkbox"/>	<input type="checkbox"/>	<input type="checkbox"/>	
	30 x 60"	WBSL3060F	<input type="checkbox"/>	<input type="checkbox"/>	<input type="checkbox"/>	<input type="checkbox"/>	<input type="checkbox"/>	<input type="checkbox"/>	<input type="checkbox"/>	<input type="checkbox"/>	<input type="checkbox"/>	<input type="checkbox"/>	<input type="checkbox"/>	<input type="checkbox"/>	
	30 x 66"	WBSL3066F	<input type="checkbox"/>	<input type="checkbox"/>	<input type="checkbox"/>	<input type="checkbox"/>	<input type="checkbox"/>	<input type="checkbox"/>	<input type="checkbox"/>	<input type="checkbox"/>	<input type="checkbox"/>	<input type="checkbox"/>	<input type="checkbox"/>	<input type="checkbox"/>	
30 x 72"	WBSL3072F	<input type="checkbox"/>	<input type="checkbox"/>	<input type="checkbox"/>	<input type="checkbox"/>	<input type="checkbox"/>	<input type="checkbox"/>	<input type="checkbox"/>	<input type="checkbox"/>	<input type="checkbox"/>	<input type="checkbox"/>	<input type="checkbox"/>	<input type="checkbox"/>		
			A	B	C	D	E	F	G	H	I	J	K	L	M

HOW TO ORDER

Indicate the following information on order form:

- Quantity of each item.
- Model number, including options. See "How To Build a Model Number".
- Any special service required.

Note: • The indicates that a choice is required.

- The absence of the indicates that no choice is required.
- Alpha-numeric characters in place of indicates that no other alternatives are available.

HOW TO BUILD A MODEL NUMBER

A Select basic model.

B Select edge style.
74P - 74P edge

C Select PowerUp® module location.
PUN - No module
PUL - Left module
PUR - Right module
PUC - Center module
PUB - Both left and right modules

PUB option only available on 60", 66" and 72" wide worksurfaces.

D Select wire trough.
NT - No wire trough
WT - Wire trough
Available in black only.

E Select electrical option.
NP - No power
T6 - T6 power
If T6 power is specified, receptacles, jumpers and infeeds are to be specified separately.

F Select frame style.
WM - w/ Modesty panel
WF - w/ Full modesty panel

G Select grommet option.
Overhead cabinet can NOT be ordered.
OGN - No worksurface grommet
OGY - Yes worksurface grommet
Grommets can be used for wire pass-through.

H Select paint color.
Refer to Finish Options on page 7.

I Select insert color.
Refer to Finish Options on page 7.

J Select laminate color.
Refer to Finish Options on page 7.

K Select edge color.
Refer to Finish Options on page 7.
Edge color offerings are based on edge style selections.

L Select grommet color.
Refer to Finish Options on page 7.

M Select PowerUp® module color.
Refer to Finish Options on page 7.

