

# VOLITION<sup>®</sup>

## DESKING SYSTEM

product offering catalog



Effective March 2014

Section/Product	Page
<b>Standard Product Overview</b>	2
Technical Specifications	4
Color Addendum	6
<b>Desks</b>	
Rectangular Worksurfaces	10
Corner Worksurfaces	12
Reduction Rectangular Worksurfaces	16
Piano Worksurfaces	18
P-Shaped Worksurfaces	19
D-Shaped Worksurfaces	20
Add-On Worksurfaces	21
Transaction Surfaces	22
Executive Desks	24
<b>Components</b>	
Privacy Screens	25
Universal Overhead Storage	29
Venus Overhead Storage	30
Universal Shelves	31
Data/Communication Accessories	32
Electrical	33
Tool Rails	35
Volition Accessories	36
Worksurface Wedge	36

# Standard Product Overview

Volition® is a freestanding desk system. Several combinations of shapes and sizes are offered to allow for an almost infinite amount of layouts. Shapes range from rectangles to piano shapes to various conference ends. Since the system is freestanding it allows for easy changes to meet the users needs.

Volition was designed with power and data needs in mind. Power and data can be hidden above or below the desk to maintain the clean look of the end user's office. All desks have grommets. Wire troughs and cord dumps keep cables organized and out of the way. Stanchions that can support overhead units also house electrical and data receptacles.

Volition easily integrates with other systems. Brackets can be added to the desks to allow them to support the PowerWorks panel systems. Power from the panel system and Volition can be connected when the systems are integrated. This makes future changes and additions easier to manage.

Volition offers several options on almost every desk. All desks offer a standard modesty panel beam but an optional panel can be added that gives the desk a full modesty configuration. Privacy screens are available for sit-down privacy or stand-up privacy. Screens can be ordered in a variety of materials to include fabrics and translucent plastic. Tool rails provide for paper and accessory management. Workstation end panels can be ordered in shorter lengths to allow for increased leg clearance.

Volition is offered in numerous painted colors, and a wide array of laminate selections are available.

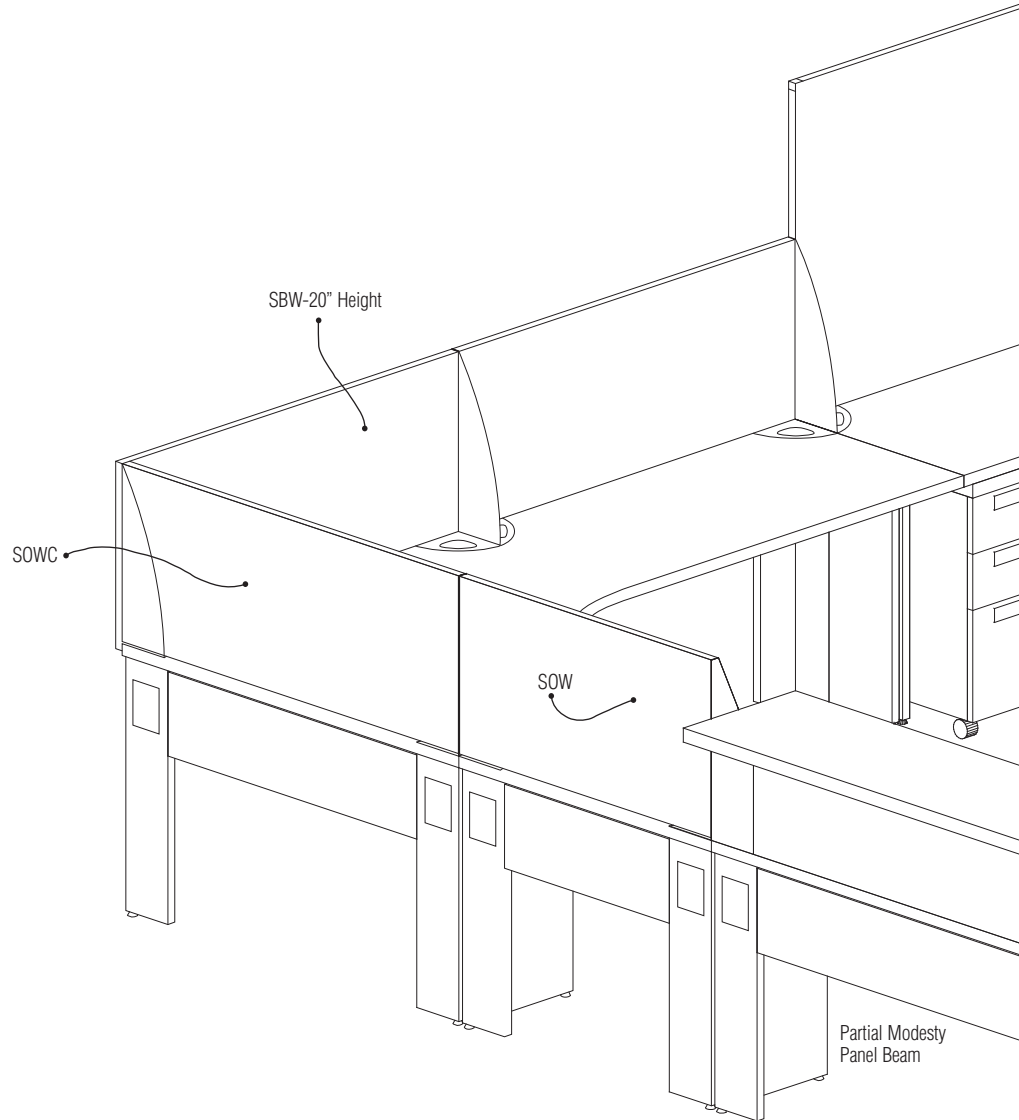

# Standard Product Overview

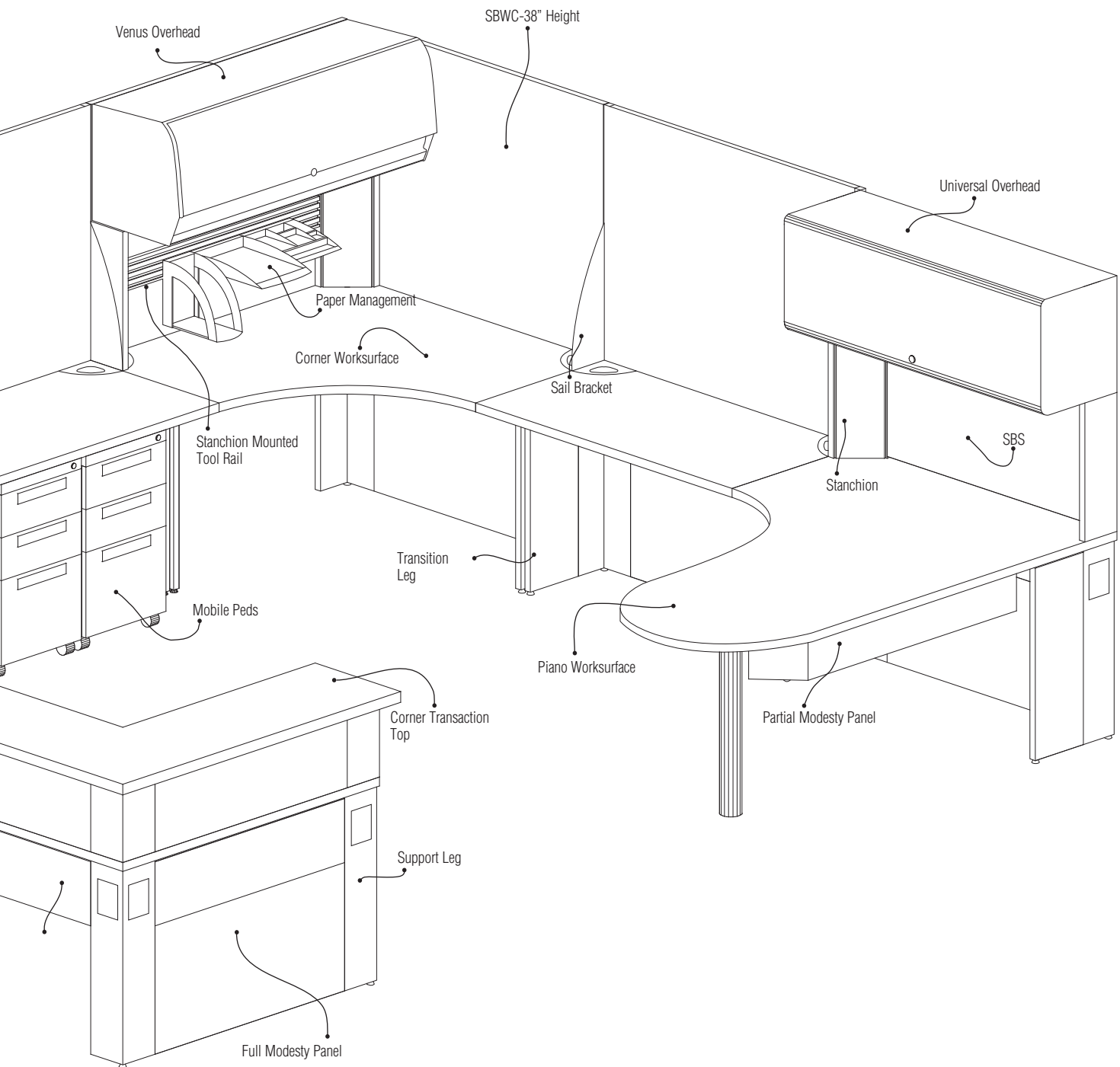

# Technical Specifications

## ANSI/BIFMA

Volition meets or exceeds the required ANSI/BIFMA X5.5-2008 desk systems standard.

## Quality

All Volition desking components shall originate from ISO 9000, ISO 9001, or ISO 9002 registered facilities.

## UL Listed

Volition desks are listed to applicable UL standards and requirements by Underwriters Laboratories Inc. Two of the standards used to evaluate Volition desks are UL 1286 Office Furnishing and UL 723 Standard Test for Surface Burning Characteristics of Building Materials.

## Basic Worksurfaces

Worksurfaces shall define the shape of the workstation and provide support for overhead storage, electrical componentry, and privacy screens. Worksurfaces shall be designed to integrate function and ergonomics to provide solutions that meet ANSI/HFS-100-1998 and ADA user requirements.

## Rectangular Worksurfaces

Worksurface tops shall be 1-1/8" high density particleboard with .03 or .04 high pressure laminate surface and .02 to .04 phenolic backing sheet. Top shall be available with a flat 2mm PVC edge in a choice of multiple colors or a 3/8" wood edge. Worksurfaces shall be available in 24", 30", 36", 42", 48", 54", 60", 66" and 72" widths and 24" and 30" depths. They shall be available in a 29" height.

Basic Rectangular worksurfaces shall include 2 triangular worksurface grommets, located in the back corners of each worksurface. 66" and 72" worksurfaces shall have 3 triangular worksurface grommets, two in the corners and one located near the back center of the desk. Grommets shall be available in BL, GR, LG, SA, TR or WG. The legs shall have (2) 3.27" x 2.27" wire management ports located in the top outside edge of each back corner. Worksurface and leg grommets will be molded from polycarbonate.

**Leg Assembly** - Each leg assembly consists of welded and assembled components which come together to form the full leg assembly. The leg assembly is attached to the underside of the worksurfaces from above. A metal leg cover can be removed from the front of the leg to gain entry to the interior of the leg. Within the leg, there is a metal structural support that can be used to separate power and data running within the leg. A glide is attached to the bottom of the leg for up to 1-1/8" of adjustability. The desk leg - Formed of 18-gage steel, overall dimensions are 6.00 x 6.00 x 27.25.

**Modesty Panel Beam** - Formed of 18-gage steel, overall dimensions are 3.00 x 9.00 x length determined by size of worksurface. The modesty panel beam is attached to the underside of the worksurface and the leg assembly. The modesty panel beam allows basic cabling to be run along the width of the desk. Plastic worksurface spacers that provide a slight stand off distance between the worksurface and modesty panel beam shall snap into place to aid installation.

**Data Modesty Panel Bracket** - A steel bracket shall be available that will attach to the underside of the modesty panel beam near the worksurface. It will have a 1.38" x 2.70" opening to accept several different manufacturers' TIA/EIA standard data faceplates.

**Lower Modesty Panel** - Optional. Formed of 18-gage steel, overall dimensions are 1.00 x 18.00 x length determined by size of worksurface. The lower modesty panel is attached to the leg assembly and will complete the full enclosure of the back of the desk.

Finish for all metal parts shall be made available in over many standard enamel colors.

**End Panel Assembly** - Each end panel consists of welded and assembled components which come

together to form the full end panel assembly. The end panel is formed of 18-gage steel and has a honeycomb core for strength and noise reduction. Overall dimensions are 1.25 x 27.00 x depth determined by worksurface size or configuration. The depth is available in three sizes based on the depth of the worksurface (24" or 30") and whether or not a transitional or full end panel configuration is desired. The end panel assembly is attached to the underside of the worksurface and the leg assembly. A glide is attached to the bottom of the end panel for up to 1-1/8" adjustability.

## Rectangular Reduction Worksurface

Rectangular reduction worksurfaces shall have the same basic construction as the rectangular worksurfaces. These worksurfaces shall have a depth of 24" on one end and 30" on the opposite end. The reduction shall be accomplished with two gently curving (12" radius) arcs that change direction halfway into the width of the worksurface. Widths of 24" to 72" in 6" increments will be available.

## Executive Worksurface

Executive worksurfaces shall have the same basic construction as the rectangular worksurfaces. These worksurfaces shall have a depth of 24" or 30" with a radius edge on the back of the worksurface. The radius edge shall extend a maximum of 6" beyond the normal depth. A right and left back corner grommet will be standard. Widths available will be 60", 66", and 72".

## Corner Worksurface

Corner worksurfaces shall have the same basic construction as the rectangular worksurfaces with an additional leg assembly, modesty panel beam, and optional lower modesty panel. In freestanding applications, standard end panels must be used. If attached to another worksurface, transitional end panels may be ordered to replace standard end panels for the sides of the attachment on both worksurfaces. Transitional legs shall be available that allow additional clearance. The front working edge will have a 16" or 22" radius depending on the size of the worksurface. Depths of 24" and 30" and widths of 48" to 72" will be standard (54" width is not available). One side is always 48" (except for a 42"/42" desk.) Three grommets, one per corner, are standard. Whenever a width is 66" or 72", a grommet will be added approximately midway of that width.

## P-Shaped and Piano Shaped Worksurfaces

P-shaped and piano shaped worksurfaces shall have the same basic construction as the rectangular worksurfaces with an additional 4" support leg and standard modesty panel. The support leg shall be attached towards the rounded front end of the worksurface. The tubular support leg will have a diameter of 4", be constructed of 14-gage steel, and have a 1-1/8" adjustable steel glide. In freestanding applications, standard end panels must be used. If attached to another worksurface, transitional end panels may be ordered to replace standard end panels for the sides of the attachment on both worksurfaces. The front working edge will have a 16" or 22" radius depending on the size of the worksurface. Depths of 60" and 72" and widths of 48" will be standard. Two grommets, one per corner, are standard.

## D-Shaped Worksurface

D-shaped worksurfaces shall have the same basic construction as the rectangular worksurfaces with an additional 4" support leg and standard modesty panel. The support leg shall be attached towards the rounded front end of the worksurface. The tubular support leg will have a diameter of 4", be constructed of 14-gage steel, and have a 1-1/8" adjustable steel glide. The width of the top shall be 24", 30", or 36". The depth shall be available in a range from 48" to 72".

## Worksurface Wedge

The worksurface wedge shall have the same basic construction as the rectangular worksurfaces with the addition of 4 splice plates & 16 screws. The wedge shall be attached between two worksurfaces that form an L-shape. It shall be a right triangle measuring 12" x 12" x 17".

## Round Add-On Worksurface

Round add-on worksurfaces shall be available with the same edge treatments as the rectangular worksurfaces. They shall be available in a diameter of 36" and 42". The 36" diameter round add-on will have a flat edge of 24" and the 42" round add-on will have a flat edge of 30". The single tubular support leg will have a diameter of 4", be constructed of 14-gage steel, and have a 1-1/8" adjustable steel glide. A pair of steel splice plates will be included to attach the round add-on to a worksurface.

## 1/2 Round Add-On Worksurface

1/2 round add-on worksurfaces shall be available with the same edge treatments as the rectangular worksurfaces. They shall be available in a diameter of 48" and 60". The 48" diameter 1/2 round add-on will have one flat edge of 48" and the 60" round add-on will have one flat edge of 60". A single tubular support leg will have a diameter of 4", be constructed of 14-gage steel, and have a 1-1/8" adjustable steel glide. The 1/2 round add-on will be able to attach to a pair of 24" or 30" worksurface ends. A pair of steel splice plates will be included to attach the 1/2 round add-on to a pair of worksurfaces.

## 1/4 Round Add-On Worksurface

1/4 round add-on worksurfaces shall be available with the same edge treatments as the rectangular worksurfaces. They shall be available in a radius of 24" and 30". A single tubular support leg will have a diameter of 4", be constructed of 14-gage steel, and have a 1-1/8" adjustable steel glide. The 1/4 round add-on will be able to bridge a pair of identical depth (24" or 30") 90° worksurface ends. It will also be able to be attached to an appropriate matching (24" or 30") edge of a single worksurface edge. A pair of steel splice plates will be included to attach the 1/4 round add-on to a pair of worksurfaces.

## Relocatable Power Tap (RPT)

The RPT shall have duplex outlets and be mountable in the overhead stanchions or transaction countertop stanchion. Two RPTs may be mountable per stanchion. Cord lengths available for RPTs shall be available with a cord length of 36" or 96". RPTs will provide above worksurface height power via an installed 10-wire electrical system or through the use of building wall outlets.

## 10-Wire Electrical Distribution System

The 10-wire system is available in two configurations (6-2-2 and 4-4-2). The UL label is green for 6-2-2 and blue for 4-4-2 applications. These numbers refer to the quantity of hot - neutral - ground wires configured in each system. Both the 6-2-2 and 4-4-2 systems may be brought into the system from the ceiling, the wall or floor, through the use of top feeds and base feeds. Volition 10-wire electrical will be able to integrate with OEI's PowerWorks panel system with the addition of the appropriate connectors.

The 10-wire electrical distribution system will consist of a 10-wire harness, table to table connectors, and a 10-wire infeed kit. The 2.16" wide double sided, rigid 10-wire harness shall mount to the underside of the modesty panel beam and shall be available in widths to span the worksurface. The 30" to 66" wide worksurface harness kit shall accommodate (2) 15 amp duplex receptacles and the 72" wide worksurface harness kit shall accommodate up to (4) 15 amp duplex receptacles.

Receptacles shall be available to access up to 6 circuits within the harness and must be ordered separately.

Both 10-wire circuits are rated at 120 vAC @ 20 amps. All receptacles are rated at 15 amps. The specifics of each wiring configuration are detailed below.

**Note: The two ten wire systems (4-4-2 and 6-2-2) cannot be mixed together. The wiring systems must be separate.**

There are different receptacles for each system, and different connectors specific to each system. Keyed connectors will not allow the 2 systems to be mixed.

## 6-2-2 Configuration

The 6-2-2 configuration of the 10-wire system will have three "convenience" circuits (1, 2, & 3) which will each have their own hot wire, will share an oversized neutral wire, and will share the building ground wire. Circuits 4, 5, & 6 are "isolated ground" circuits that will each have their own hot wire, will share an oversized neutral wire, and will share an isolated ground wire.

The advantage of this system is that it will be able to have 6 circuits coming in via one top feed or base feed. This will cut down on the number of feed points on an installation. The number 4, 5, & 6 receptacles will be colored orange to designate that they are on the isolated ground, while the number 1, 2, & 3 receptacles come in the standard trim colors.

## 4-4-2 Configuration

The 4-4-2 configuration of the 10-wire system will have two "convenience" circuits (1 & 2) which will each have their own hot wire, their own neutral wire, and will share the building ground wire. Circuits 3 & 4 are "isolated ground" which will each have their own hot wire, their own neutral wire, and will share an isolated ground wire.

The advantage of this system is that all of the circuits will have their own neutral wires, and has two circuits (3 & 4) that use an isolated ground. The number 3 & 4 receptacles will be colored orange to designate that they are on the isolated ground, while the number 1 & 2 receptacles come in the standard trim colors.

## 10-Wire Power Infeed Kit

The 10-wire power infeed kit shall provide power from fixed floor, or wall sources to the 10-wire harness. It shall include 6' of plastic covered flexible conduit. To connect the "hardwire" end of a 10-wire topfeed or basefeed to your building, use a 3/4" Romex connector on the conduit.

## 10-Wire Power Table to Table Connector

10-wire table to table connector shall consist of a sleeved flexible harness, which provides power connections from adjoining desks. The jumper shall have a length of 27".

## Power Pole

The power pole body shall be made of extruded aluminum, 16-gage, overall dimensions are 1.73 x 3.43. It will have two cavities for physical power and data separation. Length of top feed harness is 12". The power pole cover will be made of extruded aluminum, 16-gage; overall dimensions are 1.73 x 3.43 x height determined by ceiling. A plastic trim piece will cover the area where the pole intersects the ceiling.

## Privacy Screens

Privacy screens shall be available to provide sit down or stand up privacy within the Volition workstation. Screens shall be 3/4" thick, 18-1/4" and 38" high, and available in widths to fit all worksurfaces. They shall be mountable to either the overhead supports (SBS), behind the worksurface (SBW), to the top of the worksurface (SOW), or with a combination of attaching to an overhead support and a worksurface top (SSO).

Privacy screens shall be designed for straight-line applications. They shall include mounting brackets for attachment to the worksurface. Screens shall be available for straight applications in 24", 30", 36", 42", 48", 54", 60", 66", and 72" widths. The 66" and 72" widths shall consist of a pair of screens (1) 30" plus (1) 36" screen for 66" applications and (2) 36" screens with splice extrusions for 72" applications.

Screens may be used to serve 2 worksurfaces placed back to back. Privacy screens shall be useable on worksurfaces with overhead storage units to close the opening between the worksurface and the bottom of the shelf. Corner screens shall include a corner light block channel. The light block channel will also serve to align and hold the back corner together. Screens shall be available in configurations to match the worksurface application, basic worksurface, or corner worksurface.

Privacy screens will consist of two different aluminum extrusion profiles, each assembled with die-cast corner connectors to create a rectangular frame. The frames will be either upholstered or painted, depending on option. Between the two assembled frames, different core materials can be inserted. The screen material shall be made of 1/2" or 3/4" thick tackable core light or a 10mm thick non-tackable translucent plastic. The frame shall be made of extruded aluminum that is .060 in. thick. Overall dimensions of the frame shall be 1.40' x length and height dependent on desk size and screen height. The bracket extrusion shall be made of extruded aluminum. Overall dimensions are dependent on screen option and height and desk size.

#### Overstorage Mounted Privacy Screen

Same construction as above with the exception of mounting bracket. The mounting brackets shall be formed of 16-gage steel with overall dimensions of .54" x .92" x 12.38".

#### Transaction Worksurface

Transaction worksurfaces shall be available in rectangular and corner configurations. The construction of the worksurface will be similar to a standard worksurface except for shape and overall dimensions.

The transaction panel shall be formed of 18-gage steel and attach to the underside of the transaction worksurface. Depths for rectangular and corner shapes shall be 16". Overall rectangular widths available shall be from 24" to 72" in 6" increments. Overall corner transaction sizes available shall be 42" x 42", 48" x 60", 48" x 66", 48" x 72", 48" x 48", 60" x 48", 66" x 48", and 72" x 48".

Transaction Worksurface Support - Formed of 16-gage steel. Overall dimensions are 6.00" x 6.00" x height determined by height of transaction worksurface. Support Cover - R/C (QMFZ2), rated 94HB minimum or formed of 20-gage steel. Overall dimensions are 6.62" x 11.38".

#### Overhead Support Stanchion

The overhead support stanchions shall be formed of 16-gage steel, overall dimensions will be 6.00" x 6.00" x 19.50". A reinforcement plate (16-gage steel) inside the support shall have 4 cutouts that can accommodate either commercially available data plates or Removable Power Taps (RPT).

Overhead support stanchion covers shall be standard. The covers shall be made of extruded plastic and available in 5 standard trim colors. They will be hinged to allow access to the inside of the overhead support stanchions. A flexible rubber trim piece shall allow power or data cables to be run from the worksurface into the overhead support stanchions.

#### Overhead Storage

Volition shall offer 2 styles of overhead storage units for use with any worksurface. The two styles are the Universal overhead and the Venus overhead. Overheads for basic rectangular worksurfaces shall attach through the grommets in the top of the worksurface. They shall have vertical wire channels that conceal the attachment and wires from the top of the shelf to the worksurface.

Shelf dividers made of powder coated steel shall be offered in 5 standard trim colors. The installation or removal of them shall be accomplished without the use of tools or fasteners.

All overheads (Universal or Venus) shall be able to be used on System XXI, Panel Mounted or Off Module Powerworks, or Volition, depending on brackets used.

#### Universal Overheads

Overhead cabinets shall be 34" high and shall have 18-1/2" clearance between the worksurface and the bottom of shelf. The universal overhead shall be offered in widths of 24", 30", 36", 42", 48", 54", 60", 66", and 72". The flipper door opening shall be 13" high. They shall be available with doors of painted steel, fabric, laminate, or veneer. Locks shall be randomly assigned or keyed per customer requests. All 72" overheads will consist of a pair of 36" overheads. All 66" overheads will consist of a 30" and 36" overhead combination.

#### Universal Overhead Regular Shelf

Product Offering - The product shall be offered in widths of 24", 30", 36", 42", 48", 54", 60", 66", and 72". The overall dimensions of the end panels shall be 16-1/2" x 15". The shelf depth shall be 15".

Construction - The end panels shall be constructed of 14-gage steel, with a powder coat finish. The end panels shall have self-locking mounting tabs formed into the back edge. The shelf shall be an 18-gage steel weldment with a powder coat finish. The front edge of the shelf shall be a PVC extrusion that also provides space for a concealed flush mount task light.

#### Universal Overhead Low Shelf

Product Offering - The product shall be offered in widths of 24", 30", 36", 42", 48", 54", 60", 66", and 72". The overall dimensions of the end panels shall be 9-1/4" x 15". The shelf depth shall be 15".

Construction - Same as a Universal overhead regular shelf unit.

#### Venus Overhead

The cabinet sides shall be constructed of 14-gage sheet steel, while the top, back, and shelf will be constructed out of 18-gage sheet steel. Venus overheads will be offered in widths of 24", 30", 36", 42", 48", 54", 60", 66", and 72". The top, sides, back, and shelf will be resistance welded so there are no visible weld marks on the class A surfaces (outside visible surfaces). The cabinet shall be painted in the standard desk colors. The upper door shall be comprised of extruded rigid PVC. The extruded rigid PVC will be available in the 5 standard trim colors along with translucent. The lower door shall be comprised of extruded aluminum, which shall be available in the standard colors. A 10-gage hot rolled steel link arm connects the upper door and lower door. All 72" overheads will consist of one 72" shelf with a pair of 36" overhead doors. All 66" overheads will consist of one 66" shelf and a pair of 33" overhead doors.

Spring tension shall be used to assist in the opening and closing of the door. Applying pressure to the lower door opens both doors. Less than 5 pounds of force shall be needed to open both doors. The overhead door shall be able to be opened with a closed fist as well. The force and ease of opening shall make this overhead ADA compliant.

The shelf and back shall be slotted every two inches to allow for the use of shelf dividers. The underside of the shelf is also slotted with 1.5" by 1.5" slots to allow for electrical cords to run through the back.

# Volition Color Addendum

## Desks or Worksurfaces

### Grommet Color; Trim Color

Black	TBL
Blue Grey	TGR
Light Tone	TLG
Sand	TSA
Translucent	TTR
Warm Grey	TWG

### Wood Finish - Core

Cherry Storm on Maple	MCX
Cinnamon on Maple	MCN
Cocoa on Maple	MCA
Kensington Maple on Maple	MMA
Monticello Maple on Maple	MMT

## Desks or Worksurfaces

### Laminate Color

Beige Nebula	LBA
Biltmore Cherry	LBT
Black	LBK
Blue Agave	LBE
Brighton Walnut	LBW
Canyon Zephyr	LCA
Castle Oak	LCO
Cherry Storm	LCX
Cloud Nebula	LCN
Cloud Zephyr	LCL
Cocobala	LCC
Coffee Bean	LCB
Desert Zephyr	LDZ
Eggplant	LET
Frosty White	LFW
Graphite Nebula	LGN
Grey	LGE
Grey Moss	LGS
Kensington Maple	LKM
Kiwi	LKI
Loden Zephyr	LLZ
Misted Zephyr	LMR
Monticello Maple	LMT
Morro Zephyr	LMY
Nickel Evolv	LNV
North Sea	LNA
Pearl Bisque	LPB
Pearl Dust	LPD
Pearl Mist	LPE
Pearl Silver	LPS
Pomegranate	LPO
River Cherry	LRV
Satin Oxide	LSX
Satin Stainless	LSS
Shadow Zephyr	LSR
Silicon Evolv	LSV
Spiced Zephyr	LSZ
Sprout	LZP
Sweet Corn	LZC
Tangerine	LTR
Titanium Evolv	LTV
Tungsten Evolv	LTE
White Nebula	LWL
White Sand	LWN
Windsor Mahogany	LWY

## Desks or Worksurfaces

### Edge Color (3L)

Biltmore Cherry	EBT
Black	EBL
Blue Grey	EGR
Bordeaux	EBD
Brighton Walnut	EBW
Castle Oak	ECO
Cayenne	ECY
Cherry Storm	ECX
Chocolate	ECT
Cocobala	ECC
Flannel	EFN
Frosty White	EFW
Grape	EGX
Kensington Maple	EKM
Light Tone	ELG
Marine Teal	EMR
Monticello Maple	EMT
Nordic	END
River Cherry	ERY
Sand	ESA
Splash	ESH
Sunburst	ESU
Tangelo	ETO
Warm Grey	EWG
Wet Sand	EWS
Whisper	EWP
Windsor Mahogany	EWY

### Wood Edge Finish - Core

Cherry Storm on Maple	MCX
Cinnamon on Maple	MCN
Cocoa on Maple	MCA
Kensington Maple on Maple	MMA
Monticello Maple on Maple	MMT

With wood edge veneer (VN), no edge color selection required.

With PVC edge (3L) and wood edge laminate (WL)  
select from laminates.

# Volition Color Addendum

## Desks or Worksurfaces

### Desk Color

Black	BL
Blue Grey	GR
Bordeaux	BD
Bronze Metallic	ZM
Cayenne	CY
Champagne Metallic	CM
Chocolate	CT
Cottonwood	CO
Creamy White	CW
Espresso Metallic	EX
Flannel	FN
Grape	GX
Light Tone	LG
Marine Teal	MR
Nordic	ND
Sand	SA
Splash	SH
Starlight Silver Metallic	SX
Sunburst	SU
Tangelo	TO
Warm Grey	WG
Wet Sand	WS

## Components/Overhead Storage/Accessories/Electrical/Screens

### Paint Color; Cabinet Paint Color; Shelf Paint Color

Black	BL
Blue Grey	GR
Bordeaux	BD
Bronze Metallic	ZM
Cayenne	CY
Champagne Metallic	CM
Chocolate	CT
Cottonwood	CO
Creamy White	CW
Espresso Metallic	EX
Flannel	FN
Grape	GX
Light Tone	LG
Marine Teal	MR
Nordic	ND
Sand	SA
Splash	SH
Starlight Silver Metallic	SX
Sunburst	SU
Tangelo	TO
Warm Grey	WG
Wet Sand	WS

### Privacy Screen Insert Finish

Clear Wavy Acrylic	CAW
Frosted Acrylic	FAI

### Divider Screen Finish

Frosted Acrylic	FAI
-----------------	-----

### Accessory Color

Black	BL
Blue Grey	GR
Clear	CL
Light Tone	LG
Sand	SA
Warm Grey	WG

Paper Management items PPFH, PPLL, PPDS, PPVS, PPTC, PPDH, PPAT and PPPC are the only items offered a Clear (CL) accessory color option.

## Components/Overhead Storage/Accessories/Electrical/Screens

### Stanchion Door Color; Grommet Color; Trim Color

Black	TBL
Blue Grey	TGR
Light Tone	TLG
Sand	TSA
Translucent	TTR
Warm Grey	TWG

For translucent (TTR) stanchion doors, the stanchion trim piece cannot be manufactured in translucent material.

Trim piece selections are Black (WBL), Blue Grey (WGR), Light Tone (WLG), Sand (WSA) or Warm Grey (WWG). Add to model number.

### Door Handle Trim Color

Black	HBL
Blue Grey	HGR
Light Tone	HLG
Sand	HSA
Warm Grey	HWG

### Upper Door Solid Color

Black	UBL
Blue Grey	UGR
Light Tone	ULG
Sand	USA
Translucent	UTR
Warm Grey	UWG



# Volition Color Addendum

## Components/Overhead Storage/Accessories/Electrical/Screens

### Upper Door Laminate Color

Beige Nebula	LBA
Biltmore Cherry	LBT
Black	LBK
Blue Agave	LBE
Brighton Walnut	LBW
Canyon Zephyr	LCA
Castle Oak	LCO
Cherry Storm	LCX
Cloud Nebula	LCN
Cloud Zephyr	LCL
Cocobala	LCC
Coffee Bean	LCB
Desert Zephyr	LDZ
Eggplant	LET
Frosty White	LFW
Graphite Nebula	LGN
Grey	LGE
Grey Moss	LGS
Kensington Maple	LKM
Kiwi	LKI
Loden Zephyr	LLZ
Misted Zephyr	LMR
Monticello Maple	LMT
Morro Zephyr	LMY
Nickel Evolv	LNV
North Sea	LNA
Pearl Bisque	LPB
Pearl Dust	LPD
Pearl Mist	LPE
Pearl Silver	LPS
Pomegranate	LPO
River Cherry	LRV
Satin Oxide	LSX
Satin Stainless	LSS
Shadow Zephyr	LSR
Silicon Evolv	LSV
Spiced Zephyr	LSZ
Sprout	LZP
Sweet Corn	LZC
Tangerine	LTR
Titanium Evolv	LTV
Tungsten Evolv	LTE
White Nebula	LWL
White Sand	LWN
Windsor Mahogany	LWY

### Venus Laminate Door Edge Color

Black	EBL
Blue Grey	EGR
Light Tone	ELG
Sand	ESA
Warm Grey	EWG

## Components/Overhead Storage/Accessories/Electrical/Screens

### Wood Finish - Core

Cherry Storm on Maple	MCX
Cinnamon on Maple	MCN
Cocoa on Maple	MCA
Kensington Maple on Maple	MMA
Monticello Maple on Maple	MMT

### FlexStation®, and FlexStation® with power Worksurfaces/Components/Overhead Storage

#### Venus Upper Door Solid Color

Black	UBL
Blue Grey	UGR
Light Tone	ULG
Sand	USA
Translucent	UTR
Warm Grey	UWG

#### Accessory Color

Black	MBL
Blue Grey	MGR
Light Tone	MLG
Sand	MSA
Warm Grey	MWG

Data door and table-to-table wireway connector is always black.

## Components/Accessories

### Trim Color

Black	BL
Blue Grey	GR
Light Tone	LG
Sand	SA
Warm Grey	WG

The items offered in the colors above are the Universal Tasklights (UTLNxx, UTLVxx, UTLExx), Center Drawer (3CMN), and Floor Infeed (4-Circuit Pre-Wired) (WZ.PI.xx).

Tool Rails (PMTRxx) and Worksurface Connectors (87.4624.xx) are offered in the colors above as well as in Starlight Silver Metallic (SX).

### Trim Color - Paper Management

Black	BL
Blue Grey	GR
Clear	CL
Light Tone	LG
Sand	SA
Warm Grey	WG

Paper Management items that are not offered a Clear (CL) trim color are: PPMHLG, PPMHLT, PPMMD, and PPMV. These items are offered in BL, GR, LG, SA, and WG.

# Volition Color Addendum

## FlexStation®, and FlexStation® with power Worksurfaces/Components/Overhead Storage

### Paint Color

Black	BL
Blue Grey	GR
Champagne Metallic	CM
Espresso Metallic	EX
Light Tone	LG
Sand	SA
Starlight Silver	SX
Warm Grey	WG

### Insert Color

Black	IBL
Blue Grey	IGR
Light Tone	ILG
Sand	ISA
Warm Grey	IWG

### Edge Color (3L)

Biltmore Cherry*	EBT
Black Edge/Grommet	EBL
Blue Grey Edge/Grommet	EGR
Brighton Walnut*	EBW
Castle Oak*	ECO
Cherry Storm*	ECX
Cocobala	ECC
Flannel Edge/Black Grommet	EFN
Frosty White	EFW
Kensington Maple*	EKM
Light Tone Edge/Grommet	ELG
Monticello Maple*	EMT
River Cherry	ERY
Sand Edge/Grommet	ESA
Warm Grey Edge/Grommet	EWG
Wet Sand Edge/Sand Grommet	EWS
Windsor Mahogany*	EWY

\*Woodgrain edge=crank grommet/PowerUp® module will match base color. Crank handle in Black only.

### Edge Color (BN)

Black Edge/Grommet	EBL
Blue Grey Edge/Grommet	EGR
Flannel Edge/Black Grommet	EFN
Light Tone Edge/Grommet	ELG
Sand Edge/Grommet	ESA
Warm Grey Edge/Grommet	EWG
Wet Sand Edge/Sand Grommet	EWS

### Grommet Color

Black	GBL
Blue Grey	GGR
Light Tone	GLG
Sand	GSA
Warm Grey	GWG

## FlexStation®, and FlexStation® with power Worksurfaces/Components/Overhead Storage

### Laminate Upper Door Color

Beige Nebula	LBA
Biltmore Cherry	LBT
Black	LBK
Blue Agave	LBE
Brighton Walnut	LBW
Canyon Zephyr	LCA
Castle Oak	LCO
Cherry Storm	LCX
Cloud Nebula	LCN
Cloud Zephyr	LCL
Cocobala	LCC
Coffee Bean	LCB
Desert Zephyr	LDZ
Eggplant	LET
Frosty White	LFW
Graphite Nebula	LGN
Grey	LGE
Grey Moss	LGS
Kensington Maple	LKM
Kiwi	LKI
Loden Zephyr	LLZ
Misted Zephyr	LMR
Monticello Maple	LMT
Morro Zephyr	LMY
Nickel Evolv	LNV
North Sea	LNA
Pearl Bisque	LPB
Pearl Dust	LPD
Pearl Mist	LPE
Pearl Silver	LPS
Pomegranate	LPO
River Cherry	LRV
Satin Oxide	LSX
Satin Stainless	LSS
Shadow Zephyr	LSR
Silicon Evolv	LSV
Spiced Zephyr	LSZ
Sprout	LZP
Sweet Corn	LZC
Tangerine	LTR
Titanium Evolv	LTV
Tungsten Evolv	LTE
White Nebula	LWL
White Sand	LWN
Windsor Mahogany	LWY

### Venus Laminate Door Edge Color

Black	EBL
Blue Grey	EGR
Light Tone	ELG
Sand	ESA
Warm Grey	EWG

## FlexStation®, and FlexStation® with power Worksurfaces/Components/Overhead Storage

### Universal Overhead Paint Color

Black	BL
Blue Grey	GR
Champagne Metallic	CM
Espresso Metallic	EX
Light Tone	LG
Sand	SA
Starlight Silver	SX
Warm Grey	WG

### Venus Overhead Cabinet Paint Color

Black	BL
Blue Grey	GR
Bordeaux	BD
Bronze Metallic	ZM
Cayenne	CY
Champagne Metallic	CM
Chocolate	CT
Cottonwood	CO
Creamy White	CW
Espresso Metallic	EX
Flannel	FN
Grape	GX
Light Tone	LG
Marine Teal	MR
Nordic	ND
Sand	SA
Splash	SH
Starlight Silver	SX
Sunburst	SU
Tangelo	TO
Warm Grey	WG
Wet Sand	WS

# Volition Desks

## Rectangular Worksurfaces

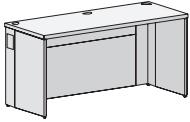

\*Standard Transition End Panels shown.

MODEL	D x W	MODEL NUMBER						
		Worksurface	Transition End Panel	Edge Style	WL Color (Optional)	Trim Color	Paint Color	Laminate
<b>Rectangular Worksurface with Full Modesty Panels</b> <ul style="list-style-type: none"> <li>Consists of top, two legs, modesty panel, optional filler panel (full modesty panel), two end panels (optional transitional size), ganging plates, and all required assembly hardware</li> <li>Each leg has two cable access grommet locations</li> <li>Top has two cable access grommets above the legs (66" and 72" have a third middle grommet)</li> <li>Top grommets allow for attachment of overhead storage units (see pages 25-27)</li> <li>Modesty panel allows for optional 10-wire electrical system (see pages 31-32)</li> </ul>	24 x 24"	VOLR2424F	<input type="checkbox"/>	<input type="checkbox"/>	<input type="checkbox"/>	<input type="checkbox"/>	<input type="checkbox"/>	<input type="checkbox"/>
	24 x 30"	VOLR2430F	<input type="checkbox"/>	<input type="checkbox"/>	<input type="checkbox"/>	<input type="checkbox"/>	<input type="checkbox"/>	<input type="checkbox"/>
	24 x 36"	VOLR2436F	<input type="checkbox"/>	<input type="checkbox"/>	<input type="checkbox"/>	<input type="checkbox"/>	<input type="checkbox"/>	<input type="checkbox"/>
	24 x 42"	VOLR2442F	<input type="checkbox"/>	<input type="checkbox"/>	<input type="checkbox"/>	<input type="checkbox"/>	<input type="checkbox"/>	<input type="checkbox"/>
	24 x 48"	VOLR2448F	<input type="checkbox"/>	<input type="checkbox"/>	<input type="checkbox"/>	<input type="checkbox"/>	<input type="checkbox"/>	<input type="checkbox"/>
	24 x 54"	VOLR2454F	<input type="checkbox"/>	<input type="checkbox"/>	<input type="checkbox"/>	<input type="checkbox"/>	<input type="checkbox"/>	<input type="checkbox"/>
	24 x 60"	VOLR2460F	<input type="checkbox"/>	<input type="checkbox"/>	<input type="checkbox"/>	<input type="checkbox"/>	<input type="checkbox"/>	<input type="checkbox"/>
	24 x 66"	VOLR2466F	<input type="checkbox"/>	<input type="checkbox"/>	<input type="checkbox"/>	<input type="checkbox"/>	<input type="checkbox"/>	<input type="checkbox"/>
	24 x 72"	VOLR2472F	<input type="checkbox"/>	<input type="checkbox"/>	<input type="checkbox"/>	<input type="checkbox"/>	<input type="checkbox"/>	<input type="checkbox"/>
	30 x 24"	VOLR3024F	<input type="checkbox"/>	<input type="checkbox"/>	<input type="checkbox"/>	<input type="checkbox"/>	<input type="checkbox"/>	<input type="checkbox"/>
	30 x 30"	VOLR3030F	<input type="checkbox"/>	<input type="checkbox"/>	<input type="checkbox"/>	<input type="checkbox"/>	<input type="checkbox"/>	<input type="checkbox"/>
	30 x 36"	VOLR3036F	<input type="checkbox"/>	<input type="checkbox"/>	<input type="checkbox"/>	<input type="checkbox"/>	<input type="checkbox"/>	<input type="checkbox"/>
	30 x 42"	VOLR3042F	<input type="checkbox"/>	<input type="checkbox"/>	<input type="checkbox"/>	<input type="checkbox"/>	<input type="checkbox"/>	<input type="checkbox"/>
	30 x 48"	VOLR3048F	<input type="checkbox"/>	<input type="checkbox"/>	<input type="checkbox"/>	<input type="checkbox"/>	<input type="checkbox"/>	<input type="checkbox"/>
	30 x 54"	VOLR3054F	<input type="checkbox"/>	<input type="checkbox"/>	<input type="checkbox"/>	<input type="checkbox"/>	<input type="checkbox"/>	<input type="checkbox"/>
	30 x 60"	VOLR3060F	<input type="checkbox"/>	<input type="checkbox"/>	<input type="checkbox"/>	<input type="checkbox"/>	<input type="checkbox"/>	<input type="checkbox"/>
	30 x 66"	VOLR3066F	<input type="checkbox"/>	<input type="checkbox"/>	<input type="checkbox"/>	<input type="checkbox"/>	<input type="checkbox"/>	<input type="checkbox"/>
	30 x 72"	VOLR3072F	<input type="checkbox"/>	<input type="checkbox"/>	<input type="checkbox"/>	<input type="checkbox"/>	<input type="checkbox"/>	<input type="checkbox"/>

A B C C D E F

### HOW TO ORDER

- Indicate the following information on order form:
- Quantity of each item.
  - Model Number, including options.  
See "How to Build a Model Number".
  - Any special service required.

Note:

- The  indicates that a choice is required.
- The absence of the  indicates that no choice is required.
- Alpha-numeric characters in place of  indicate that no other alternatives are available.

### HOW TO BUILD A MODEL NUMBER

- A** Select size of worksurface.  
**B** Select transition end panel.  
**S** = Standard  
**L** = Left transition only  
**R** = Right transition only  
**B** = Both end panels transition

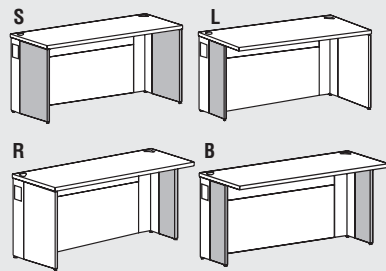

- C** Select edge style.  
**3L** = PVC edge  
**WL** = Wood edge\*  
 \*If WL is selected, see the color selection chart for wood edge designators on pg. 6.
- D** Select trim color (3L edge and grommets).  
**BL** = Black  
**GR** = Grey  
**LG** = Light Tone  
**SA** = Sand  
**WG** = Warm Grey
- E** Select paint color.  
 See pages 6-9 for color addendum.
- F** Select laminate surface.  
 See pages 6-9 for color addendum.

Specifications are subject to change without prior notice.

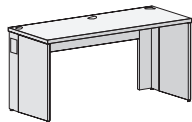

\*Standard Transition End Panels shown.

**MODEL**

**Rectangular Worksurface with Partial Modesty Panels**

- Consists of top, two legs, modesty panel, optional filler panel (partial modesty panel), two end panels (optional transitional size), ganging plates, and all required assembly hardware
- Each leg has two cable access grommet locations
- Top has two cable access grommets above the legs (66" and 72" have a third middle grommet)
- Top grommets allow for attachment of overhead storage units (see pages 25-27)
- Modesty panel allows for optional 10-wire electrical system (see pages 31-32)

D x W	MODEL NUMBER						
	Worksurface	Transition End Panel	Edge Style	WL Color (Optional)	Trim Color	Paint Color	Laminate
24 x 24"	VOLR2424P	<input type="checkbox"/>	<input type="checkbox"/>	<input type="checkbox"/>	<input type="checkbox"/>	<input type="checkbox"/>	<input type="checkbox"/>
24 x 30"	VOLR2430P	<input type="checkbox"/>	<input type="checkbox"/>	<input type="checkbox"/>	<input type="checkbox"/>	<input type="checkbox"/>	<input type="checkbox"/>
24 x 36"	VOLR2436P	<input type="checkbox"/>	<input type="checkbox"/>	<input type="checkbox"/>	<input type="checkbox"/>	<input type="checkbox"/>	<input type="checkbox"/>
24 x 42"	VOLR2442P	<input type="checkbox"/>	<input type="checkbox"/>	<input type="checkbox"/>	<input type="checkbox"/>	<input type="checkbox"/>	<input type="checkbox"/>
24 x 48"	VOLR2448P	<input type="checkbox"/>	<input type="checkbox"/>	<input type="checkbox"/>	<input type="checkbox"/>	<input type="checkbox"/>	<input type="checkbox"/>
24 x 54"	VOLR2454P	<input type="checkbox"/>	<input type="checkbox"/>	<input type="checkbox"/>	<input type="checkbox"/>	<input type="checkbox"/>	<input type="checkbox"/>
24 x 60"	VOLR2460P	<input type="checkbox"/>	<input type="checkbox"/>	<input type="checkbox"/>	<input type="checkbox"/>	<input type="checkbox"/>	<input type="checkbox"/>
24 x 66"	VOLR2466P	<input type="checkbox"/>	<input type="checkbox"/>	<input type="checkbox"/>	<input type="checkbox"/>	<input type="checkbox"/>	<input type="checkbox"/>
24 x 72"	VOLR2472P	<input type="checkbox"/>	<input type="checkbox"/>	<input type="checkbox"/>	<input type="checkbox"/>	<input type="checkbox"/>	<input type="checkbox"/>
30 x 24"	VOLR3024P	<input type="checkbox"/>	<input type="checkbox"/>	<input type="checkbox"/>	<input type="checkbox"/>	<input type="checkbox"/>	<input type="checkbox"/>
30 x 30"	VOLR3030P	<input type="checkbox"/>	<input type="checkbox"/>	<input type="checkbox"/>	<input type="checkbox"/>	<input type="checkbox"/>	<input type="checkbox"/>
30 x 36"	VOLR3036P	<input type="checkbox"/>	<input type="checkbox"/>	<input type="checkbox"/>	<input type="checkbox"/>	<input type="checkbox"/>	<input type="checkbox"/>
30 x 42"	VOLR3042P	<input type="checkbox"/>	<input type="checkbox"/>	<input type="checkbox"/>	<input type="checkbox"/>	<input type="checkbox"/>	<input type="checkbox"/>
30 x 48"	VOLR3048P	<input type="checkbox"/>	<input type="checkbox"/>	<input type="checkbox"/>	<input type="checkbox"/>	<input type="checkbox"/>	<input type="checkbox"/>
30 x 54"	VOLR3054P	<input type="checkbox"/>	<input type="checkbox"/>	<input type="checkbox"/>	<input type="checkbox"/>	<input type="checkbox"/>	<input type="checkbox"/>
30 x 60"	VOLR3060P	<input type="checkbox"/>	<input type="checkbox"/>	<input type="checkbox"/>	<input type="checkbox"/>	<input type="checkbox"/>	<input type="checkbox"/>
30 x 66"	VOLR3066P	<input type="checkbox"/>	<input type="checkbox"/>	<input type="checkbox"/>	<input type="checkbox"/>	<input type="checkbox"/>	<input type="checkbox"/>
30 x 72"	VOLR3072P	<input type="checkbox"/>	<input type="checkbox"/>	<input type="checkbox"/>	<input type="checkbox"/>	<input type="checkbox"/>	<input type="checkbox"/>

A B C OPTIONAL D E F

**HOW TO ORDER**

- Indicate the following information on order form:
1. Quantity of each item.
  2. Model Number, including options. See "How to Build a Model Number".
  3. Any special service required.

Note:

- The  indicates that a choice is required.
- The absence of the  indicates that no choice is required.
- Alpha-numeric characters in place of  indicate that no other alternatives are available.

**HOW TO BUILD A MODEL NUMBER**

- A** Select size of worksurface.
- B** Select transition end panel.
  - S** = Standard
  - L** = Left transition only
  - R** = Right transition only
  - B** = Both end panels transition
- C** Select edge style.
  - 3L** = PVC edge
  - WL** = Wood edge\*
  - \*If WL is selected, see the color selection chart for wood edge designators on pg. 6.
- D** Select trim color (3L edge and grommets).
  - BL** = Black
  - GR** = Grey
  - LG** = Light Tone
  - SA** = Sand
  - WG** = Warm Grey
- E** Select paint color. See pages 6-9 for color addendum.
- F** Select laminate surface. See pages 6-9 for color addendum.

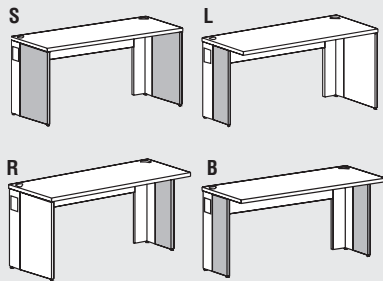

Specifications are subject to change without prior notice.

# Volition Desks

## Corner Worksurfaces

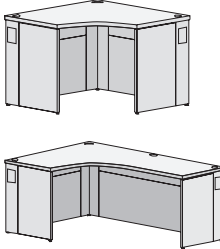
MODEL	Left D x W x D	Right W x D	MODEL NUMBER					
			Worksurface	Transition End Panel	Edge Style	WL Color (Optional)	Trim Color	Paint Color
 <p><b>Corner Worksurface with Full, Full Modesty Panels</b></p> <ul style="list-style-type: none"> <li>Consists of top, three legs, two modesty panels, two optional filler panels (full modesty panel), two end panels (optional transitional size), ganging plates, and all required assembly hardware</li> <li>Each leg has two cable access grommet locations</li> <li>Top has three cable access grommets above the legs (66" and 72" have a fourth middle grommet)</li> <li>Top grommets allow for attachment of overhead storage units (see pages 25-27)</li> <li>Modesty panel allows for optional 10-wire electrical system (see pages 31-32)</li> </ul> <p>*Standard Transition End Panels shown.</p>	<b>24 x 42" x 42 x 24"</b>	VOLC24424224FF*	<input type="checkbox"/>	<input type="checkbox"/>	<input type="checkbox"/>	<input type="checkbox"/>	<input type="checkbox"/>	<input type="checkbox"/>
	<b>24 x 48" x 48 x 24"</b>	VOLC24484824FF	<input type="checkbox"/>	<input type="checkbox"/>	<input type="checkbox"/>	<input type="checkbox"/>	<input type="checkbox"/>	<input type="checkbox"/>
	<b>24 x 48" x 60 x 24"</b>	VOLC24486024FF	<input type="checkbox"/>	<input type="checkbox"/>	<input type="checkbox"/>	<input type="checkbox"/>	<input type="checkbox"/>	<input type="checkbox"/>
	<b>24 x 48" x 66 x 24"</b>	VOLC24486624FF	<input type="checkbox"/>	<input type="checkbox"/>	<input type="checkbox"/>	<input type="checkbox"/>	<input type="checkbox"/>	<input type="checkbox"/>
	<b>24 x 48" x 72 x 24"</b>	VOLC24487224FF	<input type="checkbox"/>	<input type="checkbox"/>	<input type="checkbox"/>	<input type="checkbox"/>	<input type="checkbox"/>	<input type="checkbox"/>
	<b>24 x 60" x 48 x 24"</b>	VOLC24604824FF	<input type="checkbox"/>	<input type="checkbox"/>	<input type="checkbox"/>	<input type="checkbox"/>	<input type="checkbox"/>	<input type="checkbox"/>
	<b>24 x 66" x 48 x 24"</b>	VOLC24664824FF	<input type="checkbox"/>	<input type="checkbox"/>	<input type="checkbox"/>	<input type="checkbox"/>	<input type="checkbox"/>	<input type="checkbox"/>
	<b>24 x 72" x 48 x 24"</b>	VOLC24724824FF	<input type="checkbox"/>	<input type="checkbox"/>	<input type="checkbox"/>	<input type="checkbox"/>	<input type="checkbox"/>	<input type="checkbox"/>
	<b>30 x 48" x 48 x 30"</b>	VOLC30484830FF	<input type="checkbox"/>	<input type="checkbox"/>	<input type="checkbox"/>	<input type="checkbox"/>	<input type="checkbox"/>	<input type="checkbox"/>
	<b>30 x 48" x 60 x 30"</b>	VOLC30486030FF	<input type="checkbox"/>	<input type="checkbox"/>	<input type="checkbox"/>	<input type="checkbox"/>	<input type="checkbox"/>	<input type="checkbox"/>
	<b>30 x 48" x 66 x 30"</b>	VOLC30486630FF	<input type="checkbox"/>	<input type="checkbox"/>	<input type="checkbox"/>	<input type="checkbox"/>	<input type="checkbox"/>	<input type="checkbox"/>
	<b>30 x 48" x 72 x 30"</b>	VOLC30487230FF	<input type="checkbox"/>	<input type="checkbox"/>	<input type="checkbox"/>	<input type="checkbox"/>	<input type="checkbox"/>	<input type="checkbox"/>
	<b>30 x 60" x 48 x 30"</b>	VOLC30604830FF	<input type="checkbox"/>	<input type="checkbox"/>	<input type="checkbox"/>	<input type="checkbox"/>	<input type="checkbox"/>	<input type="checkbox"/>
	<b>30 x 66" x 48 x 30"</b>	VOLC30664830FF	<input type="checkbox"/>	<input type="checkbox"/>	<input type="checkbox"/>	<input type="checkbox"/>	<input type="checkbox"/>	<input type="checkbox"/>
	<b>30 x 72" x 48 x 30"</b>	VOLC30724830FF	<input type="checkbox"/>	<input type="checkbox"/>	<input type="checkbox"/>	<input type="checkbox"/>	<input type="checkbox"/>	<input type="checkbox"/>



### HOW TO ORDER

- Indicate the following information on order form:
- Quantity of each item.
  - Model Number, including options. See "How to Build a Model Number".
  - Any special service required.

Note:

- The  indicates that a choice is required.
- The absence of the  indicates that no choice is required.
- Alpha-numeric characters in place of  indicate that no other alternatives are available.

### HOW TO BUILD A MODEL NUMBER

- A** Select size of worksurface (left to right).
- B** Select transition end panel.
  - S** = Standard
  - L** = Left transition only
  - R** = Right transition only
  - B** = Both end panels transition
- C** Select edge style.
  - 3L** = PVC edge
  - WL** = Wood edge\*
  - \*If WL is selected, see the color selection chart for wood edge designators on pg. 6.
- D** Select trim color (3L edge and grommets).
  - BL** = Black
  - GR** = Grey
  - LG** = Light Tone
  - SA** = Sand
  - WG** = Warm Grey
- E** Select paint color. See pages 6-9 for color addendum.
- F** Select laminate surface. See pages 6-9 for color addendum.

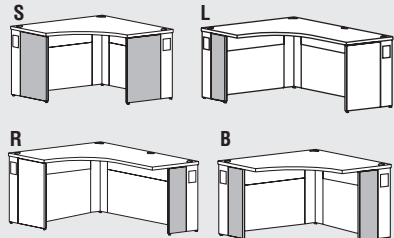

Specifications are subject to change without prior notice.

### INFORMATION

Options are always specified left to right from the seated position.

**Notes:**  
\*42" Back Left and Right only available with 24" depths.

Example:

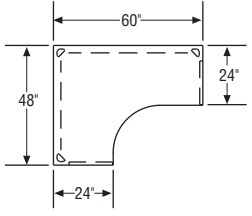

VOLC24486024FF

# Volition Desks

Corner Worksurfaces

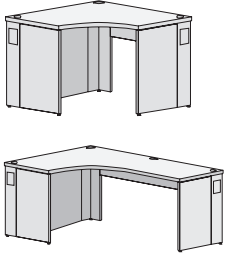
MODEL	Left D x W x D	Right W x D	MODEL NUMBER													
			Worksurface	Transition End Panel	Edge Style	WL Color (Optional)	Trim Color	Paint Color	Laminate							
 <p><b>Corner Worksurface with Full, Partial Modesty Panels</b></p> <ul style="list-style-type: none"> <li>Consists of top, three legs, two modesty panels, one optional filler panel (full modesty panel), two end panels (optional transitional size), ganging plates, and all required assembly hardware</li> <li>Each leg has two cable access grommet locations</li> <li>Top has three cable access grommets above the legs (66" and 72" have a fourth middle grommet)</li> <li>Top grommets allow for attachment of overhead storage units (see pages 25-27)</li> <li>Modesty panel allows for optional 10-wire electrical system (see pages 31-32)</li> </ul> <p>*Standard Transition End Panels shown.</p>	<b>24 x 42" x 42 x 24"</b>	<b>24 x 48" x 48 x 24"</b>	<b>24 x 48" x 60 x 24"</b>	<b>24 x 48" x 66 x 24"</b>	<b>24 x 48" x 72 x 24"</b>	<b>24 x 60" x 48 x 24"</b>	<b>24 x 66" x 48 x 24"</b>	<b>24 x 72" x 48 x 24"</b>	<b>30 x 48" x 48 x 30"</b>	<b>30 x 48" x 60 x 30"</b>	<b>30 x 48" x 66 x 30"</b>	<b>30 x 48" x 72 x 30"</b>	<b>30 x 60" x 48 x 30"</b>	<b>30 x 66" x 48 x 30"</b>	<b>30 x 72" x 48 x 30"</b>	
	VOLC24424224FP*	<input type="checkbox"/>	<input type="checkbox"/>	<input type="checkbox"/>	<input type="checkbox"/>	<input type="checkbox"/>	<input type="checkbox"/>	<input type="checkbox"/>	<input type="checkbox"/>	<input type="checkbox"/>	<input type="checkbox"/>	<input type="checkbox"/>	<input type="checkbox"/>	<input type="checkbox"/>	<input type="checkbox"/>	<input type="checkbox"/>
	VOLC24484824FP	<input type="checkbox"/>	<input type="checkbox"/>	<input type="checkbox"/>	<input type="checkbox"/>	<input type="checkbox"/>	<input type="checkbox"/>	<input type="checkbox"/>	<input type="checkbox"/>	<input type="checkbox"/>	<input type="checkbox"/>	<input type="checkbox"/>	<input type="checkbox"/>	<input type="checkbox"/>	<input type="checkbox"/>	<input type="checkbox"/>
	VOLC24486024FP	<input type="checkbox"/>	<input type="checkbox"/>	<input type="checkbox"/>	<input type="checkbox"/>	<input type="checkbox"/>	<input type="checkbox"/>	<input type="checkbox"/>	<input type="checkbox"/>	<input type="checkbox"/>	<input type="checkbox"/>	<input type="checkbox"/>	<input type="checkbox"/>	<input type="checkbox"/>	<input type="checkbox"/>	<input type="checkbox"/>
	VOLC24486624FP	<input type="checkbox"/>	<input type="checkbox"/>	<input type="checkbox"/>	<input type="checkbox"/>	<input type="checkbox"/>	<input type="checkbox"/>	<input type="checkbox"/>	<input type="checkbox"/>	<input type="checkbox"/>	<input type="checkbox"/>	<input type="checkbox"/>	<input type="checkbox"/>	<input type="checkbox"/>	<input type="checkbox"/>	<input type="checkbox"/>
	VOLC24487224FP	<input type="checkbox"/>	<input type="checkbox"/>	<input type="checkbox"/>	<input type="checkbox"/>	<input type="checkbox"/>	<input type="checkbox"/>	<input type="checkbox"/>	<input type="checkbox"/>	<input type="checkbox"/>	<input type="checkbox"/>	<input type="checkbox"/>	<input type="checkbox"/>	<input type="checkbox"/>	<input type="checkbox"/>	<input type="checkbox"/>
	VOLC24604824FP	<input type="checkbox"/>	<input type="checkbox"/>	<input type="checkbox"/>	<input type="checkbox"/>	<input type="checkbox"/>	<input type="checkbox"/>	<input type="checkbox"/>	<input type="checkbox"/>	<input type="checkbox"/>	<input type="checkbox"/>	<input type="checkbox"/>	<input type="checkbox"/>	<input type="checkbox"/>	<input type="checkbox"/>	<input type="checkbox"/>
	VOLC24664824FP	<input type="checkbox"/>	<input type="checkbox"/>	<input type="checkbox"/>	<input type="checkbox"/>	<input type="checkbox"/>	<input type="checkbox"/>	<input type="checkbox"/>	<input type="checkbox"/>	<input type="checkbox"/>	<input type="checkbox"/>	<input type="checkbox"/>	<input type="checkbox"/>	<input type="checkbox"/>	<input type="checkbox"/>	<input type="checkbox"/>
	VOLC24724824FP	<input type="checkbox"/>	<input type="checkbox"/>	<input type="checkbox"/>	<input type="checkbox"/>	<input type="checkbox"/>	<input type="checkbox"/>	<input type="checkbox"/>	<input type="checkbox"/>	<input type="checkbox"/>	<input type="checkbox"/>	<input type="checkbox"/>	<input type="checkbox"/>	<input type="checkbox"/>	<input type="checkbox"/>	<input type="checkbox"/>
	VOLC30484830FP	<input type="checkbox"/>	<input type="checkbox"/>	<input type="checkbox"/>	<input type="checkbox"/>	<input type="checkbox"/>	<input type="checkbox"/>	<input type="checkbox"/>	<input type="checkbox"/>	<input type="checkbox"/>	<input type="checkbox"/>	<input type="checkbox"/>	<input type="checkbox"/>	<input type="checkbox"/>	<input type="checkbox"/>	<input type="checkbox"/>
	VOLC30486030FP	<input type="checkbox"/>	<input type="checkbox"/>	<input type="checkbox"/>	<input type="checkbox"/>	<input type="checkbox"/>	<input type="checkbox"/>	<input type="checkbox"/>	<input type="checkbox"/>	<input type="checkbox"/>	<input type="checkbox"/>	<input type="checkbox"/>	<input type="checkbox"/>	<input type="checkbox"/>	<input type="checkbox"/>	<input type="checkbox"/>
	VOLC30486630FP	<input type="checkbox"/>	<input type="checkbox"/>	<input type="checkbox"/>	<input type="checkbox"/>	<input type="checkbox"/>	<input type="checkbox"/>	<input type="checkbox"/>	<input type="checkbox"/>	<input type="checkbox"/>	<input type="checkbox"/>	<input type="checkbox"/>	<input type="checkbox"/>	<input type="checkbox"/>	<input type="checkbox"/>	<input type="checkbox"/>
	VOLC30487230FP	<input type="checkbox"/>	<input type="checkbox"/>	<input type="checkbox"/>	<input type="checkbox"/>	<input type="checkbox"/>	<input type="checkbox"/>	<input type="checkbox"/>	<input type="checkbox"/>	<input type="checkbox"/>	<input type="checkbox"/>	<input type="checkbox"/>	<input type="checkbox"/>	<input type="checkbox"/>	<input type="checkbox"/>	<input type="checkbox"/>
	VOLC30604830FP	<input type="checkbox"/>	<input type="checkbox"/>	<input type="checkbox"/>	<input type="checkbox"/>	<input type="checkbox"/>	<input type="checkbox"/>	<input type="checkbox"/>	<input type="checkbox"/>	<input type="checkbox"/>	<input type="checkbox"/>	<input type="checkbox"/>	<input type="checkbox"/>	<input type="checkbox"/>	<input type="checkbox"/>	<input type="checkbox"/>
	VOLC30664830FP	<input type="checkbox"/>	<input type="checkbox"/>	<input type="checkbox"/>	<input type="checkbox"/>	<input type="checkbox"/>	<input type="checkbox"/>	<input type="checkbox"/>	<input type="checkbox"/>	<input type="checkbox"/>	<input type="checkbox"/>	<input type="checkbox"/>	<input type="checkbox"/>	<input type="checkbox"/>	<input type="checkbox"/>	<input type="checkbox"/>
VOLC30724830FP	<input type="checkbox"/>	<input type="checkbox"/>	<input type="checkbox"/>	<input type="checkbox"/>	<input type="checkbox"/>	<input type="checkbox"/>	<input type="checkbox"/>	<input type="checkbox"/>	<input type="checkbox"/>	<input type="checkbox"/>	<input type="checkbox"/>	<input type="checkbox"/>	<input type="checkbox"/>	<input type="checkbox"/>	<input type="checkbox"/>	

**A** **B** **C** **C** **D** **E** **F**  
OPTIONAL

### HOW TO ORDER

- Indicate the following information on order form:
- Quantity of each item.
  - Model Number, including options. See "How to Build a Model Number".
  - Any special service required.

- Note:
- The  indicates that a choice is required.
  - The absence of the  indicates that no choice is required.
  - Alpha-numeric characters in place of  indicate that no other alternatives are available.

### HOW TO BUILD A MODEL NUMBER

- A** Select size of worksurface (left to right).
  - S** = Standard
  - L** = Left transition only
  - R** = Right transition only
  - B** = Both end panels transition
- B** Select transition end panel.
  - S** = Standard
  - L** = Left transition only
  - R** = Right transition only
  - B** = Both end panels transition
- C** Select edge style.
  - 3L** = PVC edge
  - WL** = Wood edge\*

\*If WL is selected, see the color selection chart for wood edge designators on pg. 6.
- D** Select trim color (3L edge and grommets).
  - BL** = Black
  - GR** = Grey
  - LG** = Light Tone
  - SA** = Sand
  - WG** = Warm Grey
- E** Select paint color. See pages 6-9 for color addendum.
- F** Select laminate surface. See pages 6-9 for color addendum.

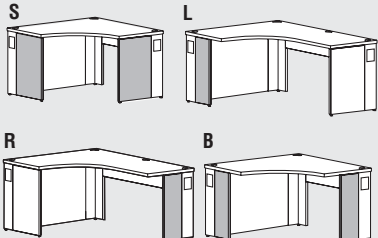

Specifications are subject to change without prior notice.

### INFORMATION

Options are always specified left to right from the seated position.

**Notes:**  
\*42" Back Left and Right only available with 24" depths.

Example:

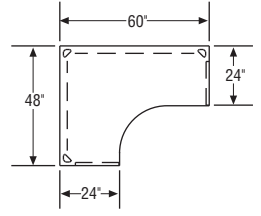

VOLC24486024FP

# Volition Desks

## Corner Worksurfaces

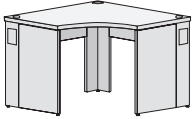
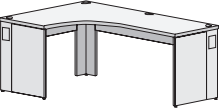
MODEL	Left D x W x W x D	Right W x D	MODEL NUMBER							
			Worksurface	Transition End Panel	Edge Style	WL Color (Optional)	Trim Color	Paint Color	Laminate	
  <p>*Standard Transition End Panels shown.</p> <p><b>Corner Worksurface with Partial, Partial Modesty Panels</b></p> <ul style="list-style-type: none"> <li>Consists of top, three legs, two modesty panels, two end panels (optional transitional size), ganging plates, and all required assembly hardware</li> <li>Each leg has two cable access grommet locations</li> <li>Top has three cable access grommets above the legs (66" and 72" have a fourth middle grommet)</li> <li>Top grommets allow for attachment of overhead storage units (see pages 25-27)</li> <li>Modesty panel allows for optional 10-wire electrical system (see pages 31-32)</li> </ul>	<b>24 x 42" x 42 x 24"</b>		VOLC24424224PP*	<input type="checkbox"/>	<input type="checkbox"/>	<input type="checkbox"/>	<input type="checkbox"/>	<input type="checkbox"/>	<input type="checkbox"/>	<input type="checkbox"/>
	<b>24 x 48" x 48 x 24"</b>		VOLC24484824PP	<input type="checkbox"/>	<input type="checkbox"/>	<input type="checkbox"/>	<input type="checkbox"/>	<input type="checkbox"/>	<input type="checkbox"/>	<input type="checkbox"/>
	<b>24 x 48" x 60 x 24"</b>		VOLC24486024PP	<input type="checkbox"/>	<input type="checkbox"/>	<input type="checkbox"/>	<input type="checkbox"/>	<input type="checkbox"/>	<input type="checkbox"/>	<input type="checkbox"/>
	<b>24 x 48" x 66 x 24"</b>		VOLC24486624PP	<input type="checkbox"/>	<input type="checkbox"/>	<input type="checkbox"/>	<input type="checkbox"/>	<input type="checkbox"/>	<input type="checkbox"/>	<input type="checkbox"/>
	<b>24 x 48" x 72 x 24"</b>		VOLC24487224PP	<input type="checkbox"/>	<input type="checkbox"/>	<input type="checkbox"/>	<input type="checkbox"/>	<input type="checkbox"/>	<input type="checkbox"/>	<input type="checkbox"/>
	<b>24 x 60" x 48 x 24"</b>		VOLC24604824PP	<input type="checkbox"/>	<input type="checkbox"/>	<input type="checkbox"/>	<input type="checkbox"/>	<input type="checkbox"/>	<input type="checkbox"/>	<input type="checkbox"/>
	<b>24 x 66" x 48 x 24"</b>		VOLC24664824PP	<input type="checkbox"/>	<input type="checkbox"/>	<input type="checkbox"/>	<input type="checkbox"/>	<input type="checkbox"/>	<input type="checkbox"/>	<input type="checkbox"/>
	<b>24 x 72" x 48 x 24"</b>		VOLC24724824PP	<input type="checkbox"/>	<input type="checkbox"/>	<input type="checkbox"/>	<input type="checkbox"/>	<input type="checkbox"/>	<input type="checkbox"/>	<input type="checkbox"/>
	<b>30 x 48" x 48 x 30"</b>		VOLC30484830PP	<input type="checkbox"/>	<input type="checkbox"/>	<input type="checkbox"/>	<input type="checkbox"/>	<input type="checkbox"/>	<input type="checkbox"/>	<input type="checkbox"/>
	<b>30 x 48" x 60 x 30"</b>		VOLC30486030PP	<input type="checkbox"/>	<input type="checkbox"/>	<input type="checkbox"/>	<input type="checkbox"/>	<input type="checkbox"/>	<input type="checkbox"/>	<input type="checkbox"/>
	<b>30 x 48" x 66 x 30"</b>		VOLC30486630PP	<input type="checkbox"/>	<input type="checkbox"/>	<input type="checkbox"/>	<input type="checkbox"/>	<input type="checkbox"/>	<input type="checkbox"/>	<input type="checkbox"/>
	<b>30 x 48" x 72 x 30"</b>		VOLC30487230PP	<input type="checkbox"/>	<input type="checkbox"/>	<input type="checkbox"/>	<input type="checkbox"/>	<input type="checkbox"/>	<input type="checkbox"/>	<input type="checkbox"/>
	<b>30 x 60" x 48 x 30"</b>		VOLC30604830PP	<input type="checkbox"/>	<input type="checkbox"/>	<input type="checkbox"/>	<input type="checkbox"/>	<input type="checkbox"/>	<input type="checkbox"/>	<input type="checkbox"/>
	<b>30 x 66" x 48 x 30"</b>		VOLC30664830PP	<input type="checkbox"/>	<input type="checkbox"/>	<input type="checkbox"/>	<input type="checkbox"/>	<input type="checkbox"/>	<input type="checkbox"/>	<input type="checkbox"/>
	<b>30 x 72" x 48 x 30"</b>		VOLC30724830PP	<input type="checkbox"/>	<input type="checkbox"/>	<input type="checkbox"/>	<input type="checkbox"/>	<input type="checkbox"/>	<input type="checkbox"/>	<input type="checkbox"/>



### HOW TO ORDER

- Indicate the following information on order form:
- Quantity of each item.
  - Model Number, including options. See "How to Build a Model Number".
  - Any special service required.

- Note:
- The  indicates that a choice is required.
  - The absence of the  indicates that no choice is required.
  - Alpha-numeric characters in place of  indicate that no other alternatives are available.

### HOW TO BUILD A MODEL NUMBER

- A** Select size of worksurface (left to right).
- B** Select transition end panel.
  - S** = Standard
  - L** = Left transition only
  - R** = Right transition only
  - B** = Both end panels transition
- C** Select edge style.
  - 3L** = PVC edge
  - WL** = Wood edge\*
  - \*If WL is selected, see the color selection chart for wood edge designators on pg. 6.
- D** Select trim color (3L edge and grommets).
  - BL** = Black
  - GR** = Grey
  - LG** = Light Tone
  - SA** = Sand
  - WG** = Warm Grey
- E** Select paint color. See pages 6-9 for color addendum.
- F** Select laminate surface. See pages 6-9 for color addendum.

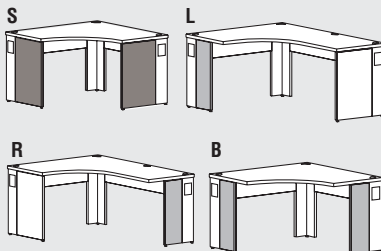

Specifications are subject to change without prior notice.

### INFORMATION

Options are always specified left to right from the seated position.

**Notes:**  
\*42" Back Left and Right only available with 24" depths.

Example:

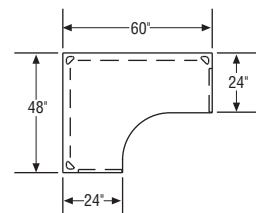

VOLC24486024PP

# Volition Desks

Corner Worksurfaces

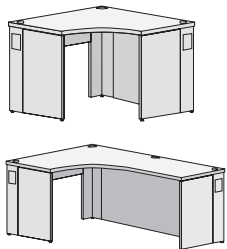
MODEL	Left D x W x D	Right W x D	MODEL NUMBER					
			Worksurface	Transition End Panel	Edge Style	WL Color (Optional)	Trim Color	Paint Color
 <p><b>Corner Worksurface with Partial, Full Modesty Panels</b></p> <ul style="list-style-type: none"> <li>Consists of top, three legs, two modesty panels, two optional filler panels (partial modesty panel), two end panels (optional transitional size), ganging plates, and all required assembly hardware</li> <li>Each leg has two cable access grommet locations</li> <li>Top has three cable access grommets above the legs (66" and 72" have a fourth middle grommet)</li> <li>Top grommets allow for attachment of overhead storage units (see pages 25-27)</li> <li>Modesty panel allows for optional 10-wire electrical system (see pages 31-32)</li> </ul> <p>*Standard Transition End Panels shown.</p>	<b>24 x 42" x 42 x 24"</b>	VOLC24424224PF*	<input type="checkbox"/>	<input type="checkbox"/>	<input type="checkbox"/>	<input type="checkbox"/>	<input type="checkbox"/>	<input type="checkbox"/>
	<b>24 x 48" x 48 x 24"</b>	VOLC24484824PF	<input type="checkbox"/>	<input type="checkbox"/>	<input type="checkbox"/>	<input type="checkbox"/>	<input type="checkbox"/>	<input type="checkbox"/>
	<b>24 x 48" x 60 x 24"</b>	VOLC24486024PF	<input type="checkbox"/>	<input type="checkbox"/>	<input type="checkbox"/>	<input type="checkbox"/>	<input type="checkbox"/>	<input type="checkbox"/>
	<b>24 x 48" x 66 x 24"</b>	VOLC24486624PF	<input type="checkbox"/>	<input type="checkbox"/>	<input type="checkbox"/>	<input type="checkbox"/>	<input type="checkbox"/>	<input type="checkbox"/>
	<b>24 x 48" x 72 x 24"</b>	VOLC24487224PF	<input type="checkbox"/>	<input type="checkbox"/>	<input type="checkbox"/>	<input type="checkbox"/>	<input type="checkbox"/>	<input type="checkbox"/>
	<b>24 x 60" x 48 x 24"</b>	VOLC24604824PF	<input type="checkbox"/>	<input type="checkbox"/>	<input type="checkbox"/>	<input type="checkbox"/>	<input type="checkbox"/>	<input type="checkbox"/>
	<b>24 x 66" x 48 x 24"</b>	VOLC24664824PF	<input type="checkbox"/>	<input type="checkbox"/>	<input type="checkbox"/>	<input type="checkbox"/>	<input type="checkbox"/>	<input type="checkbox"/>
	<b>24 x 72" x 48 x 24"</b>	VOLC24724824PF	<input type="checkbox"/>	<input type="checkbox"/>	<input type="checkbox"/>	<input type="checkbox"/>	<input type="checkbox"/>	<input type="checkbox"/>
	<b>30 x 48" x 48 x 30"</b>	VOLC30484830PF	<input type="checkbox"/>	<input type="checkbox"/>	<input type="checkbox"/>	<input type="checkbox"/>	<input type="checkbox"/>	<input type="checkbox"/>
	<b>30 x 48" x 60 x 30"</b>	VOLC30486030PF	<input type="checkbox"/>	<input type="checkbox"/>	<input type="checkbox"/>	<input type="checkbox"/>	<input type="checkbox"/>	<input type="checkbox"/>
	<b>30 x 48" x 66 x 30"</b>	VOLC30486630PF	<input type="checkbox"/>	<input type="checkbox"/>	<input type="checkbox"/>	<input type="checkbox"/>	<input type="checkbox"/>	<input type="checkbox"/>
	<b>30 x 48" x 72 x 30"</b>	VOLC30487230PF	<input type="checkbox"/>	<input type="checkbox"/>	<input type="checkbox"/>	<input type="checkbox"/>	<input type="checkbox"/>	<input type="checkbox"/>
	<b>30 x 60" x 48 x 30"</b>	VOLC30604830PF	<input type="checkbox"/>	<input type="checkbox"/>	<input type="checkbox"/>	<input type="checkbox"/>	<input type="checkbox"/>	<input type="checkbox"/>
	<b>30 x 66" x 48 x 30"</b>	VOLC30664830PF	<input type="checkbox"/>	<input type="checkbox"/>	<input type="checkbox"/>	<input type="checkbox"/>	<input type="checkbox"/>	<input type="checkbox"/>
	<b>30 x 72" x 48 x 30"</b>	VOLC30724830PF	<input type="checkbox"/>	<input type="checkbox"/>	<input type="checkbox"/>	<input type="checkbox"/>	<input type="checkbox"/>	<input type="checkbox"/>



### HOW TO ORDER

- Indicate the following information on order form:
- Quantity of each item.
  - Model Number, including options. See "How to Build a Model Number".
  - Any special service required.

- Note:
- The  indicates that a choice is required.
  - The absence of the  indicates that no choice is required.
  - Alpha-numeric characters in place of  indicate that no other alternatives are available.

### HOW TO BUILD A MODEL NUMBER

- A** Select size of worksurface (left to right).
- B** Select transition end panel.
  - S** = Standard
  - L** = Left transition only
  - R** = Right transition only
  - B** = Both end panels transition
- C** Select edge style.
  - 3L** = PVC edge
  - WL** = Wood edge\*
  - \*If WL is selected, see the color selection chart for wood edge designators on pg. 6.
- D** Select trim color (3L edge and grommets).
  - BL** = Black
  - GR** = Grey
  - LG** = Light Tone
  - SA** = Sand
  - WG** = Warm Grey
- E** Select paint color. See pages 6-9 for color addendum.
- F** Select laminate surface. See pages 6-9 for color addendum.

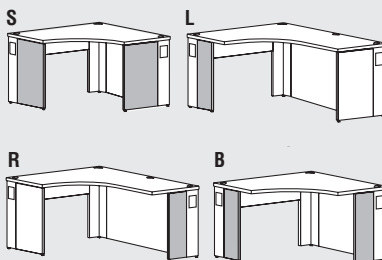

Specifications are subject to change without prior notice.

### INFORMATION

Options are always specified left to right from the seated position.

**Notes:**  
\*42" Back Left and Right only available with 24" depths.

Example:

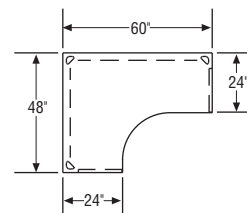

VOLC24486024PF



# Volition Desks

## Reduction Rectangular Worksurfaces

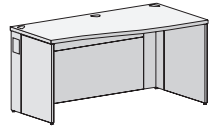

\*Standard Transition End Panels shown.

**MODEL**

**Reduction Rectangular with Full Modesty Panel**

- Desk reduces size from 24" on one end to 30" on opposite end
- Consists of top, two legs, modesty panel, optional filler panel (full modesty panel), two end panels (optional transitional size), ganging plates, and all required assembly hardware
- Each leg has two cable access grommet locations
- Top has two cable access grommets above the legs (66" and 72" have a third middle grommet)
- Top grommets allow for attachment of overhead storage units (see pages 25-27)
- Modesty panel allows for optional 10-wire electrical system (see pages 31-32)

Left D x W x D	Right D x W x D	MODEL NUMBER						
		Worksurface	Transition End Panel	Edge Style	WL Color (Optional)	Trim Color	Paint Color	Laminate
24 x 42 x 30"		VOLRR244230F	<input type="checkbox"/>	<input type="checkbox"/>	<input type="checkbox"/>	<input type="checkbox"/>	<input type="checkbox"/>	<input type="checkbox"/>
24 x 48 x 30"		VOLRR244830F	<input type="checkbox"/>	<input type="checkbox"/>	<input type="checkbox"/>	<input type="checkbox"/>	<input type="checkbox"/>	<input type="checkbox"/>
24 x 54 x 30"		VOLRR245430F	<input type="checkbox"/>	<input type="checkbox"/>	<input type="checkbox"/>	<input type="checkbox"/>	<input type="checkbox"/>	<input type="checkbox"/>
24 x 60 x 30"		VOLRR246030F	<input type="checkbox"/>	<input type="checkbox"/>	<input type="checkbox"/>	<input type="checkbox"/>	<input type="checkbox"/>	<input type="checkbox"/>
24 x 66 x 30"		VOLRR246630F	<input type="checkbox"/>	<input type="checkbox"/>	<input type="checkbox"/>	<input type="checkbox"/>	<input type="checkbox"/>	<input type="checkbox"/>
24 x 72 x 30"		VOLRR247230F	<input type="checkbox"/>	<input type="checkbox"/>	<input type="checkbox"/>	<input type="checkbox"/>	<input type="checkbox"/>	<input type="checkbox"/>
30 x 42 x 24"		VOLRR304224F	<input type="checkbox"/>	<input type="checkbox"/>	<input type="checkbox"/>	<input type="checkbox"/>	<input type="checkbox"/>	<input type="checkbox"/>
30 x 48 x 24"		VOLRR304824F	<input type="checkbox"/>	<input type="checkbox"/>	<input type="checkbox"/>	<input type="checkbox"/>	<input type="checkbox"/>	<input type="checkbox"/>
30 x 54 x 24"		VOLRR305424F	<input type="checkbox"/>	<input type="checkbox"/>	<input type="checkbox"/>	<input type="checkbox"/>	<input type="checkbox"/>	<input type="checkbox"/>
30 x 60 x 24"		VOLRR306024F	<input type="checkbox"/>	<input type="checkbox"/>	<input type="checkbox"/>	<input type="checkbox"/>	<input type="checkbox"/>	<input type="checkbox"/>
30 x 66 x 24"		VOLRR306624F	<input type="checkbox"/>	<input type="checkbox"/>	<input type="checkbox"/>	<input type="checkbox"/>	<input type="checkbox"/>	<input type="checkbox"/>
30 x 72 x 24"		VOLRR307224F	<input type="checkbox"/>	<input type="checkbox"/>	<input type="checkbox"/>	<input type="checkbox"/>	<input type="checkbox"/>	<input type="checkbox"/>

A B C C OPTIONAL D E F

### HOW TO ORDER

- Indicate the following information on order form:
- Quantity of each item.
  - Model Number, including options.  
See "How to Build a Model Number".
  - Any special service required.

- Note:
- The  indicates that a choice is required.
  - The absence of the  indicates that no choice is required.
  - Alpha-numeric characters in place of  indicate that no other alternatives are available.

### HOW TO BUILD A MODEL NUMBER

- A** Select size of worksurface (left to right).
- B** Select transition end panel.
  - S** = Standard
  - L** = Left transition only
  - R** = Right transition only
  - B** = Both end panels transition
- C** Select edge style.
  - 3L** = PVC edge
  - WL** = Wood edge\*
  - \*If WL is selected, see the color selection chart for wood edge designators on pg. 6.
- D** Select trim color (3L edge and grommets).
  - BL** = Black
  - GR** = Grey
  - LG** = Light Tone
  - SA** = Sand
  - WG** = Warm Grey
- E** Select paint color.  
See pages 6-9 for color addendum.
- F** Select laminate surface.  
See pages 6-9 for color addendum.

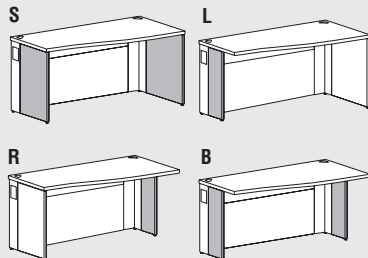

Specifications are subject to change without prior notice.

### INFORMATION

Size is specified left to right from the seated position.

Example:

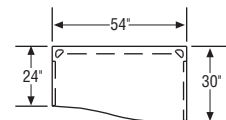

VOLRR245430F

# Volition Desks

Reduction Rectangular Worksurfaces

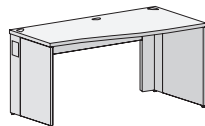

\*Standard Transition End Panels shown.

### Reduction Rectangular with Partial Modesty Panel

- Desk reduces size from 24" on one end to 30" on opposite end
- Consists of top, two legs, modesty panel, two end panels (optional transitional size), ganging plates, and all required assembly hardware
- Each leg has two cable access grommet locations
- Top has two cable access grommets above the legs (66" and 72" have a third middle grommet)
- Top grommets allow for attachment of overhead storage units (see pages 25-27)
- Modesty panel allows for optional 10-wire electrical system (see pages 31-32)

### MODEL NUMBER

MODEL	Left D x W x D	Right D	MODEL NUMBER							
			Worksurface	Transition End Panel	Edge Style	WL Color (Optional)	Trim Color	Paint Color	Laminate	
	24 x 42 x 30"		VOLRR244230P	<input type="checkbox"/>	<input type="checkbox"/>	<input type="checkbox"/>	<input type="checkbox"/>	<input type="checkbox"/>	<input type="checkbox"/>	<input type="checkbox"/>
	24 x 48 x 30"		VOLRR244830P	<input type="checkbox"/>	<input type="checkbox"/>	<input type="checkbox"/>	<input type="checkbox"/>	<input type="checkbox"/>	<input type="checkbox"/>	<input type="checkbox"/>
	24 x 54 x 30"		VOLRR245430P	<input type="checkbox"/>	<input type="checkbox"/>	<input type="checkbox"/>	<input type="checkbox"/>	<input type="checkbox"/>	<input type="checkbox"/>	<input type="checkbox"/>
	24 x 60 x 30"		VOLRR246030P	<input type="checkbox"/>	<input type="checkbox"/>	<input type="checkbox"/>	<input type="checkbox"/>	<input type="checkbox"/>	<input type="checkbox"/>	<input type="checkbox"/>
	24 x 66 x 30"		VOLRR246630P	<input type="checkbox"/>	<input type="checkbox"/>	<input type="checkbox"/>	<input type="checkbox"/>	<input type="checkbox"/>	<input type="checkbox"/>	<input type="checkbox"/>
	24 x 72 x 30"		VOLRR247230P	<input type="checkbox"/>	<input type="checkbox"/>	<input type="checkbox"/>	<input type="checkbox"/>	<input type="checkbox"/>	<input type="checkbox"/>	<input type="checkbox"/>
	30 x 42 x 24"		VOLRR304224P	<input type="checkbox"/>	<input type="checkbox"/>	<input type="checkbox"/>	<input type="checkbox"/>	<input type="checkbox"/>	<input type="checkbox"/>	<input type="checkbox"/>
	30 x 48 x 24"		VOLRR304824P	<input type="checkbox"/>	<input type="checkbox"/>	<input type="checkbox"/>	<input type="checkbox"/>	<input type="checkbox"/>	<input type="checkbox"/>	<input type="checkbox"/>
	30 x 54 x 24"		VOLRR305424P	<input type="checkbox"/>	<input type="checkbox"/>	<input type="checkbox"/>	<input type="checkbox"/>	<input type="checkbox"/>	<input type="checkbox"/>	<input type="checkbox"/>
	30 x 60 x 24"		VOLRR306024P	<input type="checkbox"/>	<input type="checkbox"/>	<input type="checkbox"/>	<input type="checkbox"/>	<input type="checkbox"/>	<input type="checkbox"/>	<input type="checkbox"/>
	30 x 66 x 24"		VOLRR306624P	<input type="checkbox"/>	<input type="checkbox"/>	<input type="checkbox"/>	<input type="checkbox"/>	<input type="checkbox"/>	<input type="checkbox"/>	<input type="checkbox"/>
	30 x 72 x 24"		VOLRR307224P	<input type="checkbox"/>	<input type="checkbox"/>	<input type="checkbox"/>	<input type="checkbox"/>	<input type="checkbox"/>	<input type="checkbox"/>	<input type="checkbox"/>

A B C C OPTIONAL D E F

### HOW TO ORDER

Indicate the following information on order form:

1. Quantity of each item.
2. Model Number, including options. See "How to Build a Model Number".
3. Any special service required.

- Note:
- The  indicates that a choice is required.
  - The absence of the  indicates that no choice is required.
  - Alpha-numeric characters in place of  indicate that no other alternatives are available.

### HOW TO BUILD A MODEL NUMBER

**A** Select size of worksurface (left to right).

**B** Select transition end panel.

- S** = Standard
- L** = Left transition only
- R** = Right transition only
- B** = Both end panels transition

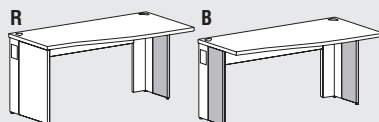
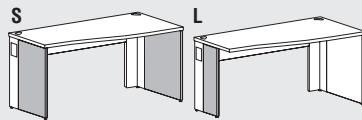

**C** Select edge style.

- 3L** = PVC edge
- WL** = Wood edge\*

\*If WL is selected, see the color selection chart for wood edge designators on pg. 6.

**D** Select trim color (3L edge and grommets).

- BL** = Black
- GR** = Grey
- LG** = Light Tone
- SA** = Sand
- WG** = Warm Grey

**E** Select paint color. See pages 6-9 for color addendum.

**F** Select laminate surface. See pages 6-9 for color addendum.

Specifications are subject to change without prior notice.

### INFORMATION

Size is specified left to right from the seated position.

Example:

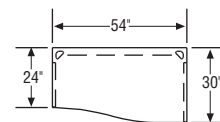

VOLRR245430P

# Volition Desks

## Piano Worksurfaces

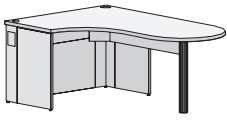
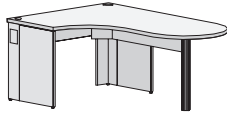
MODEL	Left D x W x D	Right W x D	MODEL NUMBER								
			Worksurface	Transition End Panel	Edge Style	WL Color (Optional)	Trim Color	Paint Color	Laminate		
 <p><b>Piano Worksurface with Full Modesty Panel</b></p> <ul style="list-style-type: none"> <li>Consists of top, two legs, modesty panel, optional filler panel (full modesty panel), two end panels (optional transitional size), ganging plates, one round leg, one 9" tall steel partial modesty panel along the 60" or 72" side, and all required assembly hardware</li> <li>Each leg has two cable access grommet locations</li> <li>Top has two cable access grommets above the legs</li> <li>Top grommets allow for attachment of overhead storage units (see pages 25-27)</li> <li>Modesty panel allows for optional 10-wire electrical system (see pages 31-32)</li> <li>Piano end is 30" wide (15" radius)</li> </ul> <p>*Standard Transition End Panels shown.</p>	<b>24 x 48 x 60"</b>										
	<b>24 x 48 x 66"</b>										
	<b>24 x 48 x 72"</b>										
	<b>30 x 48 x 66"</b>										
	<b>30 x 48 x 72"</b>										
	<b>60 x 48 x 24"</b>										
	<b>72 x 48 x 24"</b>										
	<b>72 x 48 x 30"</b>										
 <p><b>Piano Worksurface with Partial Modesty Panel</b></p> <ul style="list-style-type: none"> <li>Consists of top, two legs, modesty panel, two end panels (optional transitional size), ganging plates, one round leg, one 9" tall steel partial modesty panel along the 60" or 72" side, and all required assembly hardware</li> <li>Each leg has two cable access grommet locations</li> <li>Top has two cable access grommets above the legs</li> <li>Top grommets allow for attachment of overhead storage units (see pages 25-27)</li> <li>Modesty panel allows for optional 10-wire electrical system (see pages 31-32)</li> <li>Piano end is 30" wide (15" radius)</li> </ul> <p>*Standard Transition End Panels shown.</p>	<b>24 x 48 x 60"</b>										
	<b>24 x 48 x 66"</b>										
	<b>24 x 48 x 72"</b>										
	<b>30 x 48 x 66"</b>										
	<b>30 x 48 x 72"</b>										
	<b>60 x 48 x 24"</b>										
	<b>72 x 48 x 24"</b>										
	<b>72 x 48 x 30"</b>										



### HOW TO ORDER

- Indicate the following information on order form:
- Quantity of each item.
  - Model Number, including options. See "How to Build a Model Number".
  - Any special service required.

- Note:
- The  indicates that a choice is required.
  - The absence of the  indicates that no choice is required.
  - Alpha-numeric characters in place of  indicate that no other alternatives are available.

### HOW TO BUILD A MODEL NUMBER

- A** Select size of worksurface (left to right).
- B** Select transition end panel.
  - S** = Standard
  - L** = Left transition only
  - R** = Right transition only
  - B** = Both end panels transition
- C** Select edge style.
  - 3L** = PVC edge
  - WL** = Wood edge\*
  - \*If WL is selected, see the color selection chart for wood edge designators on pg. 6.
- D** Select trim color (3L edge and grommets).
  - BL** = Black
  - GR** = Grey
  - LG** = Light Tone
  - SA** = Sand
  - WG** = Warm Grey
- E** Select paint color. See pages 6-9 for color addendum.
- F** Select laminate surface. See pages 6-9 for color addendum.

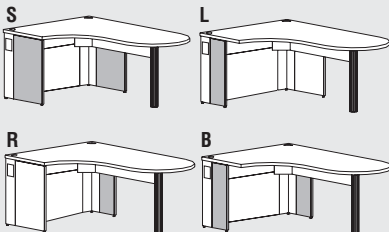

Specifications are subject to change without prior notice.

### INFORMATION

Size is specified left to right from the seated position.

Example:

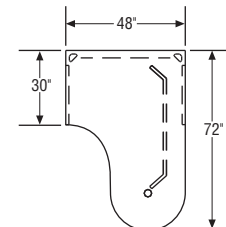

VOLPO304872F or VOLPO304872P

# Volition Desks

P-Shaped Worksurfaces

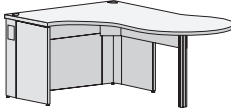
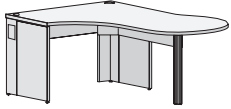
MODEL	Left D x W x D	Right D x W x D	MODEL NUMBER														
			Worksurface	Transition End Panel	Edge Style	WL Color (Optional)	Trim Color	Paint Color	Laminate								
 <p><b>P-Shaped Desk with Full Modesty Panel</b></p> <ul style="list-style-type: none"> <li>Consists of top, two legs, modesty panel, optional filler panel (full modesty panel), two end panels (optional transitional size), ganging plates, one round leg, one 9" tall steel partial modesty panel along the 60" or 72" side, and all required assembly hardware</li> <li>Each leg has two cable access grommet locations</li> <li>Top has two cable access grommets above the legs</li> <li>Top grommets allow for attachment of overhead storage units (see pages 25-27)</li> <li>Modesty panel allows for optional 10-wire electrical system (see pages 31-32)</li> <li>P-end is 18" radius</li> </ul>	<b>24 x 48 x 60"</b>	<b>24 x 48 x 66"</b>	<b>24 x 48 x 72"</b>	<b>30 x 48 x 66"</b>	<b>30 x 48 x 72"</b>	<b>60 x 48 x 24"</b>	<b>72 x 48 x 24"</b>	<b>72 x 48 x 30"</b>									
	VOLPD244860F	<input type="checkbox"/>	<input type="checkbox"/>	<input type="checkbox"/>	<input type="checkbox"/>	<input type="checkbox"/>	<input type="checkbox"/>	<input type="checkbox"/>	<input type="checkbox"/>								
	VOLPD244866F	<input type="checkbox"/>	<input type="checkbox"/>	<input type="checkbox"/>	<input type="checkbox"/>	<input type="checkbox"/>	<input type="checkbox"/>	<input type="checkbox"/>	<input type="checkbox"/>								
	VOLPD244872F	<input type="checkbox"/>	<input type="checkbox"/>	<input type="checkbox"/>	<input type="checkbox"/>	<input type="checkbox"/>	<input type="checkbox"/>	<input type="checkbox"/>	<input type="checkbox"/>								
	VOLPD304866F	<input type="checkbox"/>	<input type="checkbox"/>	<input type="checkbox"/>	<input type="checkbox"/>	<input type="checkbox"/>	<input type="checkbox"/>	<input type="checkbox"/>	<input type="checkbox"/>								
	VOLPD304872F	<input type="checkbox"/>	<input type="checkbox"/>	<input type="checkbox"/>	<input type="checkbox"/>	<input type="checkbox"/>	<input type="checkbox"/>	<input type="checkbox"/>	<input type="checkbox"/>								
	VOLPD604824F	<input type="checkbox"/>	<input type="checkbox"/>	<input type="checkbox"/>	<input type="checkbox"/>	<input type="checkbox"/>	<input type="checkbox"/>	<input type="checkbox"/>	<input type="checkbox"/>								
VOLPD724824F	<input type="checkbox"/>	<input type="checkbox"/>	<input type="checkbox"/>	<input type="checkbox"/>	<input type="checkbox"/>	<input type="checkbox"/>	<input type="checkbox"/>	<input type="checkbox"/>									
VOLPD724830F	<input type="checkbox"/>	<input type="checkbox"/>	<input type="checkbox"/>	<input type="checkbox"/>	<input type="checkbox"/>	<input type="checkbox"/>	<input type="checkbox"/>	<input type="checkbox"/>									
 <p><b>P-Shaped Desk with Partial Modesty Panel</b></p> <ul style="list-style-type: none"> <li>Consists of top, two legs, modesty panel, two end panels (optional transitional size), ganging plates, one round leg, one 9" tall steel partial modesty panel along the 60" or 72" side, and all required assembly hardware</li> <li>Each leg has two cable access grommet locations</li> <li>Top has two cable access grommets above the legs</li> <li>Top grommets allow for attachment of overhead storage units (see pages 25-27)</li> <li>Modesty panel allows for optional 10-wire electrical system (see pages 31-32)</li> <li>P-end is 18" radius</li> </ul>	<b>24 x 48 x 60"</b>	<b>24 x 48 x 66"</b>	<b>24 x 48 x 72"</b>	<b>30 x 48 x 66"</b>	<b>30 x 48 x 72"</b>	<b>60 x 48 x 24"</b>	<b>72 x 48 x 24"</b>	<b>72 x 48 x 30"</b>									
	VOLPD244860P	<input type="checkbox"/>	<input type="checkbox"/>	<input type="checkbox"/>	<input type="checkbox"/>	<input type="checkbox"/>	<input type="checkbox"/>	<input type="checkbox"/>	<input type="checkbox"/>								
	VOLPD244866P	<input type="checkbox"/>	<input type="checkbox"/>	<input type="checkbox"/>	<input type="checkbox"/>	<input type="checkbox"/>	<input type="checkbox"/>	<input type="checkbox"/>	<input type="checkbox"/>								
	VOLPD244872P	<input type="checkbox"/>	<input type="checkbox"/>	<input type="checkbox"/>	<input type="checkbox"/>	<input type="checkbox"/>	<input type="checkbox"/>	<input type="checkbox"/>	<input type="checkbox"/>								
	VOLPD304866P	<input type="checkbox"/>	<input type="checkbox"/>	<input type="checkbox"/>	<input type="checkbox"/>	<input type="checkbox"/>	<input type="checkbox"/>	<input type="checkbox"/>	<input type="checkbox"/>								
	VOLPD304872P	<input type="checkbox"/>	<input type="checkbox"/>	<input type="checkbox"/>	<input type="checkbox"/>	<input type="checkbox"/>	<input type="checkbox"/>	<input type="checkbox"/>	<input type="checkbox"/>								
	VOLPD604824P	<input type="checkbox"/>	<input type="checkbox"/>	<input type="checkbox"/>	<input type="checkbox"/>	<input type="checkbox"/>	<input type="checkbox"/>	<input type="checkbox"/>	<input type="checkbox"/>								
VOLPD724824P	<input type="checkbox"/>	<input type="checkbox"/>	<input type="checkbox"/>	<input type="checkbox"/>	<input type="checkbox"/>	<input type="checkbox"/>	<input type="checkbox"/>	<input type="checkbox"/>									
VOLPD724830P	<input type="checkbox"/>	<input type="checkbox"/>	<input type="checkbox"/>	<input type="checkbox"/>	<input type="checkbox"/>	<input type="checkbox"/>	<input type="checkbox"/>	<input type="checkbox"/>									

\*Standard Transition End Panels shown.

\*Standard Transition End Panels shown.

**A**      **B**      **C**      **C** (OPTIONAL)      **D**      **E**      **F**

### HOW TO ORDER

- Indicate the following information on order form:
- Quantity of each item.
  - Model Number, including options. See "How to Build a Model Number".
  - Any special service required.

- Note:
- The  indicates that a choice is required.
  - The absence of the  indicates that no choice is required.
  - Alpha-numeric characters in place of  indicate that no other alternatives are available.

### HOW TO BUILD A MODEL NUMBER

- A** Select size of worksurface (left to right).
  - S** = Standard
  - L** = Left transition only
  - R** = Right transition only
  - B** = Both end panels transition
- B** Select transition end panel.
  - S** = Standard
  - L** = Left transition only
  - R** = Right transition only
  - B** = Both end panels transition
- C** Select edge style.
  - 3L** = PVC edge
  - WL** = Wood edge\*
  - \*If WL is selected, see the color selection chart for wood edge designators on pg. 6.
- D** Select trim color (3L edge and grommets).
  - BL** = Black
  - GR** = Grey
  - LG** = Light Tone
  - SA** = Sand
  - WG** = Warm Grey
- E** Select paint color. See pages 6-9 for color addendum.
- F** Select laminate surface. See pages 6-9 for color addendum.

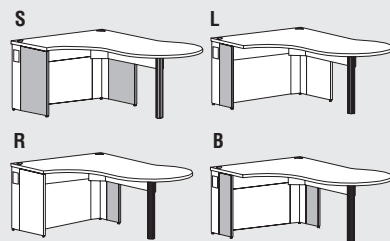

Specifications are subject to change without prior notice.

### INFORMATION

Size is specified left to right from the seated position.

Example:

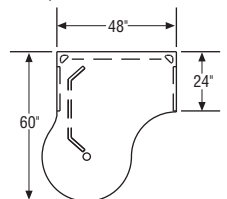

VOLPD604824F or VOLPD604824P

# Volition Desks

## D-Shaped Worksurfaces

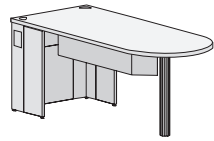

\*Both End Panels Transition shown.

**MODEL**

**D-Shaped Desk with Full Modesty Panel**

- Consists of top, two legs, modesty panel, optional filler panel (full modesty panel), two transitional size end panels, ganging plates, one round leg, one 9" tall steel partial modesty panel along the 60" or 72" side, and all required assembly hardware
- Each leg has two cable access grommet locations
- Top has two cable access grommets above the legs
- Top grommets allow for attachment of overhead storage units (see pages 25-27)
- Modesty panel allows for optional 10-wire electrical system (see pages 31-32)

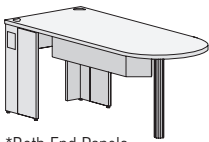

\*Both End Panels Transition shown.

**D-Shaped Desk with Partial Modesty Panel**

- Consists of top, two legs, modesty panel, two transitional size end panels, ganging plates, one round leg, one 9" tall steel partial modesty panel along the 60" or 72" side, and all required assembly hardware
- Each leg has two cable access grommet locations
- Top has two cable access grommets above the legs
- Top grommets allow for attachment of overhead storage units (see pages 25-27)
- Modesty panel allows for optional 10-wire electrical system (see pages 31-32)

**MODEL NUMBER**

MODEL	L x D	MODEL NUMBER						
		Worksurface	Transition End Panel	Edge Style	WL Color (Optional)	Trim Color	Paint Color	Laminate
<b>D-Shaped Desk with Full Modesty Panel</b>	24 x 48"	VOLDD2448F	B	<input type="checkbox"/>	<input type="checkbox"/>	<input type="checkbox"/>	<input type="checkbox"/>	<input type="checkbox"/>
	24 x 54"	VOLDD2454F	B	<input type="checkbox"/>	<input type="checkbox"/>	<input type="checkbox"/>	<input type="checkbox"/>	<input type="checkbox"/>
	24 x 60"	VOLDD2460F	B	<input type="checkbox"/>	<input type="checkbox"/>	<input type="checkbox"/>	<input type="checkbox"/>	<input type="checkbox"/>
	24 x 66"	VOLDD2466F	B	<input type="checkbox"/>	<input type="checkbox"/>	<input type="checkbox"/>	<input type="checkbox"/>	<input type="checkbox"/>
	24 x 72"	VOLDD2472F	B	<input type="checkbox"/>	<input type="checkbox"/>	<input type="checkbox"/>	<input type="checkbox"/>	<input type="checkbox"/>
	30 x 48"	VOLDD3048F	B	<input type="checkbox"/>	<input type="checkbox"/>	<input type="checkbox"/>	<input type="checkbox"/>	<input type="checkbox"/>
	30 x 54"	VOLDD3054F	B	<input type="checkbox"/>	<input type="checkbox"/>	<input type="checkbox"/>	<input type="checkbox"/>	<input type="checkbox"/>
	30 x 60"	VOLDD3060F	B	<input type="checkbox"/>	<input type="checkbox"/>	<input type="checkbox"/>	<input type="checkbox"/>	<input type="checkbox"/>
	30 x 66"	VOLDD3066F	B	<input type="checkbox"/>	<input type="checkbox"/>	<input type="checkbox"/>	<input type="checkbox"/>	<input type="checkbox"/>
	30 x 72"	VOLDD3072F	B	<input type="checkbox"/>	<input type="checkbox"/>	<input type="checkbox"/>	<input type="checkbox"/>	<input type="checkbox"/>
	36 x 48"	VOLDD3648F	B	<input type="checkbox"/>	<input type="checkbox"/>	<input type="checkbox"/>	<input type="checkbox"/>	<input type="checkbox"/>
	36 x 54"	VOLDD3654F	B	<input type="checkbox"/>	<input type="checkbox"/>	<input type="checkbox"/>	<input type="checkbox"/>	<input type="checkbox"/>
	36 x 60"	VOLDD3660F	B	<input type="checkbox"/>	<input type="checkbox"/>	<input type="checkbox"/>	<input type="checkbox"/>	<input type="checkbox"/>
	36 x 66"	VOLDD3666F	B	<input type="checkbox"/>	<input type="checkbox"/>	<input type="checkbox"/>	<input type="checkbox"/>	<input type="checkbox"/>
	36 x 72"	VOLDD3672F	B	<input type="checkbox"/>	<input type="checkbox"/>	<input type="checkbox"/>	<input type="checkbox"/>	<input type="checkbox"/>
	<b>D-Shaped Desk with Partial Modesty Panel</b>	24 x 48"	VOLDD2448P	B	<input type="checkbox"/>	<input type="checkbox"/>	<input type="checkbox"/>	<input type="checkbox"/>
24 x 54"		VOLDD2454P	B	<input type="checkbox"/>	<input type="checkbox"/>	<input type="checkbox"/>	<input type="checkbox"/>	<input type="checkbox"/>
24 x 60"		VOLDD2460P	B	<input type="checkbox"/>	<input type="checkbox"/>	<input type="checkbox"/>	<input type="checkbox"/>	<input type="checkbox"/>
24 x 66"		VOLDD2466P	B	<input type="checkbox"/>	<input type="checkbox"/>	<input type="checkbox"/>	<input type="checkbox"/>	<input type="checkbox"/>
24 x 72"		VOLDD2472P	B	<input type="checkbox"/>	<input type="checkbox"/>	<input type="checkbox"/>	<input type="checkbox"/>	<input type="checkbox"/>
30 x 48"		VOLDD3048P	B	<input type="checkbox"/>	<input type="checkbox"/>	<input type="checkbox"/>	<input type="checkbox"/>	<input type="checkbox"/>
30 x 54"		VOLDD3054P	B	<input type="checkbox"/>	<input type="checkbox"/>	<input type="checkbox"/>	<input type="checkbox"/>	<input type="checkbox"/>
30 x 60"		VOLDD3060P	B	<input type="checkbox"/>	<input type="checkbox"/>	<input type="checkbox"/>	<input type="checkbox"/>	<input type="checkbox"/>
30 x 66"		VOLDD3066P	B	<input type="checkbox"/>	<input type="checkbox"/>	<input type="checkbox"/>	<input type="checkbox"/>	<input type="checkbox"/>
30 x 72"		VOLDD3072P	B	<input type="checkbox"/>	<input type="checkbox"/>	<input type="checkbox"/>	<input type="checkbox"/>	<input type="checkbox"/>
36 x 48"		VOLDD3648P	B	<input type="checkbox"/>	<input type="checkbox"/>	<input type="checkbox"/>	<input type="checkbox"/>	<input type="checkbox"/>
36 x 54"		VOLDD3654P	B	<input type="checkbox"/>	<input type="checkbox"/>	<input type="checkbox"/>	<input type="checkbox"/>	<input type="checkbox"/>
36 x 60"	VOLDD3660P	B	<input type="checkbox"/>	<input type="checkbox"/>	<input type="checkbox"/>	<input type="checkbox"/>	<input type="checkbox"/>	
36 x 66"	VOLDD3666P	B	<input type="checkbox"/>	<input type="checkbox"/>	<input type="checkbox"/>	<input type="checkbox"/>	<input type="checkbox"/>	
36 x 72"	VOLDD3672P	B	<input type="checkbox"/>	<input type="checkbox"/>	<input type="checkbox"/>	<input type="checkbox"/>	<input type="checkbox"/>	

**A**      **B**      **C**      **C** (OPTIONAL)      **D**      **E**      **F**

**HOW TO ORDER**

- Indicate the following information on order form:
1. Quantity of each item.
  2. Model Number, including options. See "How to Build a Model Number".
  3. Any special service required.

- Note:
- The  indicates that a choice is required.
  - The absence of the  indicates that no choice is required.
  - Alpha-numeric characters in place of  indicate that no other alternatives are available.



**HOW TO BUILD A MODEL NUMBER**

- A** Select size of worksurface (left to right)
- B** Select transition end panel  
**B** = Both end panels transition
- C** Select edge style  
**3L** = PVC edge  
**WL** = Wood edge\*  
\*If WL is selected, see the color selection chart for wood edge designators on pg. 6.
- D** Select trim color (3L edge and grommets)  
**BL** = Black  
**GR** = Grey  
**LG** = Light Tone  
**SA** = Sand  
**WG** = Warm Grey
- E** Select paint color (includes column leg)  
See pages 6-9 for color addendum.
- F** Select laminate surface  
See pages 6-9 for color addendum.

**Specifications are subject to change without prior notice.**

## Volition Desks

Add-On Worksurfaces

MODEL	D x dia.	MODEL NUMBER					
		Worksurface	Edge Style	WL Color (Optional)	Trim Color	Paint Color	Laminate
 <p><b>Round Add-On Worksurface</b></p> <ul style="list-style-type: none"> <li>Consists of top, 36" or 42" diameter, ganging plates for attaching to existing desks, and all required assembly hardware</li> </ul>	<b>24 x 36" dia</b>	VOLRA2436	<input type="checkbox"/>	<input type="checkbox"/>	<input type="checkbox"/>	<input type="checkbox"/>	<input type="checkbox"/>
	<b>30 x 42" dia</b>	VOLRA3042	<input type="checkbox"/>	<input type="checkbox"/>	<input type="checkbox"/>	<input type="checkbox"/>	<input type="checkbox"/>
	<b>D x Rad.</b>						
 <p><b>Half Round Add-On Worksurface</b></p> <ul style="list-style-type: none"> <li>Consists of top, 24" or 30" radius, ganging plates for attaching to existing desks, and all required assembly hardware</li> </ul>	<b>48 x 24" rad</b>	VOLHA2448	<input type="checkbox"/>	<input type="checkbox"/>	<input type="checkbox"/>	<input type="checkbox"/>	<input type="checkbox"/>
	<b>60 x 30" rad</b>	VOLHA3060	<input type="checkbox"/>	<input type="checkbox"/>	<input type="checkbox"/>	<input type="checkbox"/>	<input type="checkbox"/>
	<b>D x Rad.</b>						
 <p><b>Quarter Round Add-On Worksurface</b></p> <ul style="list-style-type: none"> <li>Consists of top, 24" or 30" radius, ganging plates for attaching to existing desks, and all required assembly hardware</li> </ul>	<b>24 x 24" rad</b>	VOLQA2424	<input type="checkbox"/>	<input type="checkbox"/>	<input type="checkbox"/>	<input type="checkbox"/>	<input type="checkbox"/>
	<b>30 x 30" rad</b>	VOLQA3030	<input type="checkbox"/>	<input type="checkbox"/>	<input type="checkbox"/>	<input type="checkbox"/>	<input type="checkbox"/>
	<b>D x Rad.</b>						

A

B

B

C

D

E

OPTIONAL

## HOW TO ORDER

Indicate the following information on order form:

- Quantity of each item.
- Model Number, including options. See "How to Build a Model Number".
- Any special service required.

- Note:
- The  indicates that a choice is required.
  - The absence of the  indicates that no choice is required.
  - Alpha-numeric characters in place of  indicate that no other alternatives are available.

## HOW TO BUILD A MODEL NUMBER

- A** Select size of worksurface (left to right).  
\_\_\_\_\_
- B** Select edge style.  
**3L** = PVC edge  
**WL** = Wood edge\*  
 \*If WL is selected, see the color selection chart for wood edge designators on pg. 6.
- C** Select trim color (3L edge).  
**BL** = Black  
**GR** = Grey  
**LG** = Light Tone  
**SA** = Sand  
**WG** = Warm Grey
- D** Select paint color (column leg).  
 See pages 6-9 for color addendum.
- E** Select laminate surface.  
 See pages 6-9 for color addendum.

Specifications are subject to change without prior notice.

## INFORMATION

The first dimension in the model number refers to the length of the straight edge.

# Volition Desks

## Transaction Surfaces

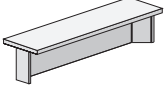
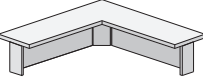
MODEL	Length	MODEL NUMBER					
		Worksurface	Edge Style	WL Color (Optional)	Trim Color	Paint Color	Laminate
 <p><b>Transaction Counter Standard Height Straight</b></p> <ul style="list-style-type: none"> <li>Consists of a top, two stanchions, steel privacy panel, and all required assembly hardware</li> <li>Top of transaction surface is approximately 42" from floor</li> <li>Space below transaction surface = 11½"</li> </ul>	24"	VOLTSS24	<input type="checkbox"/>	<input type="checkbox"/>	<input type="checkbox"/>	<input type="checkbox"/>	<input type="checkbox"/>
	30"	VOLTSS30	<input type="checkbox"/>	<input type="checkbox"/>	<input type="checkbox"/>	<input type="checkbox"/>	<input type="checkbox"/>
	36"	VOLTSS36	<input type="checkbox"/>	<input type="checkbox"/>	<input type="checkbox"/>	<input type="checkbox"/>	<input type="checkbox"/>
	42"	VOLTSS42	<input type="checkbox"/>	<input type="checkbox"/>	<input type="checkbox"/>	<input type="checkbox"/>	<input type="checkbox"/>
	48"	VOLTSS48	<input type="checkbox"/>	<input type="checkbox"/>	<input type="checkbox"/>	<input type="checkbox"/>	<input type="checkbox"/>
	54"	VOLTSS54	<input type="checkbox"/>	<input type="checkbox"/>	<input type="checkbox"/>	<input type="checkbox"/>	<input type="checkbox"/>
	60"	VOLTSS60	<input type="checkbox"/>	<input type="checkbox"/>	<input type="checkbox"/>	<input type="checkbox"/>	<input type="checkbox"/>
	66"	VOLTSS66	<input type="checkbox"/>	<input type="checkbox"/>	<input type="checkbox"/>	<input type="checkbox"/>	<input type="checkbox"/>
	72"	VOLTSS72	<input type="checkbox"/>	<input type="checkbox"/>	<input type="checkbox"/>	<input type="checkbox"/>	<input type="checkbox"/>
	Left Length x Right Length						
 <p><b>Transaction Counter Standard Height Corner</b></p> <ul style="list-style-type: none"> <li>Consists of a top, three stanchions, steel privacy panels, and all required assembly hardware</li> <li>Top of transaction surface is approximately 42" from floor</li> <li>Space below transaction surface = 11½"</li> </ul>	42 x 42"	VOLTSC4242	<input type="checkbox"/>	<input type="checkbox"/>	<input type="checkbox"/>	<input type="checkbox"/>	<input type="checkbox"/>
	48 x 48"	VOLTSC4848	<input type="checkbox"/>	<input type="checkbox"/>	<input type="checkbox"/>	<input type="checkbox"/>	<input type="checkbox"/>
	48 x 60"	VOLTSC4860	<input type="checkbox"/>	<input type="checkbox"/>	<input type="checkbox"/>	<input type="checkbox"/>	<input type="checkbox"/>
	48 x 66"	VOLTSC4866	<input type="checkbox"/>	<input type="checkbox"/>	<input type="checkbox"/>	<input type="checkbox"/>	<input type="checkbox"/>
	48 x 72"	VOLTSC4872	<input type="checkbox"/>	<input type="checkbox"/>	<input type="checkbox"/>	<input type="checkbox"/>	<input type="checkbox"/>
	60 x 48"	VOLTSC6048	<input type="checkbox"/>	<input type="checkbox"/>	<input type="checkbox"/>	<input type="checkbox"/>	<input type="checkbox"/>
	66 x 48"	VOLTSC6648	<input type="checkbox"/>	<input type="checkbox"/>	<input type="checkbox"/>	<input type="checkbox"/>	<input type="checkbox"/>
	72 x 48"	VOLTSC7248	<input type="checkbox"/>	<input type="checkbox"/>	<input type="checkbox"/>	<input type="checkbox"/>	<input type="checkbox"/>

A

B

B

OPTIONAL

C

D

E

### HOW TO ORDER

Indicate the following information on order form:

- Quantity of each item.
- Model Number, including options.  
See "How to Build a Model Number".
- Any special service required.

- Note:
- The  indicates that a choice is required.
  - The absence of the  indicates that no choice is required.
  - Alpha-numeric characters in place of  indicate that no other alternatives are available.

### HOW TO BUILD A MODEL NUMBER

- A** Select size of worksurface (left to right).
- B** Select edge style.  
**3L** = PVC edge  
**WL** = Wood edge\*  
 \*If WL is selected, see the color selection chart for wood edge designators on pg. 6.
- C** Select trim color (3L edge and stanchion cover).  
**BL** = Black  
**GR** = Grey  
**LG** = Light Tone  
**SA** = Sand  
**WG** = Warm Grey
- D** Select paint color. (Stanchions and below surface panel).  
 See pages 6-9 for color addendum.
- E** Select laminate surface.  
 See pages 6-9 for color addendum.



Specifications are subject to change without prior notice.

### INFORMATION

Transaction surfaces must be used above a desk of the same size.

# Volition Desks

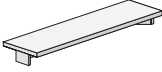
Transaction Surfaces

MODEL	Length	MODEL NUMBER						
		Worksurface	Edge Style	WL Color (Optional)	Trim Color	Paint Color	Laminate	
 <p><b>Transaction Counter Low Height Straight</b></p> <ul style="list-style-type: none"> <li>Consists of a top, two stanchions, steel privacy panel, and all required assembly hardware</li> <li>Top of transaction surface is approximately 34" from floor</li> <li>Space below transaction surface = 3 3/4"</li> </ul>	24"	VOLTLS24	<input type="checkbox"/>	<input type="checkbox"/>	<input type="checkbox"/>	<input type="checkbox"/>	<input type="checkbox"/>	<input type="checkbox"/>
	30"	VOLTLS30	<input type="checkbox"/>	<input type="checkbox"/>	<input type="checkbox"/>	<input type="checkbox"/>	<input type="checkbox"/>	<input type="checkbox"/>
	36"	VOLTLS36	<input type="checkbox"/>	<input type="checkbox"/>	<input type="checkbox"/>	<input type="checkbox"/>	<input type="checkbox"/>	<input type="checkbox"/>
	42"	VOLTLS42	<input type="checkbox"/>	<input type="checkbox"/>	<input type="checkbox"/>	<input type="checkbox"/>	<input type="checkbox"/>	<input type="checkbox"/>
	48"	VOLTLS48	<input type="checkbox"/>	<input type="checkbox"/>	<input type="checkbox"/>	<input type="checkbox"/>	<input type="checkbox"/>	<input type="checkbox"/>
	54"	VOLTLS54	<input type="checkbox"/>	<input type="checkbox"/>	<input type="checkbox"/>	<input type="checkbox"/>	<input type="checkbox"/>	<input type="checkbox"/>
	60"	VOLTLS60	<input type="checkbox"/>	<input type="checkbox"/>	<input type="checkbox"/>	<input type="checkbox"/>	<input type="checkbox"/>	<input type="checkbox"/>
	66"	VOLTLS66	<input type="checkbox"/>	<input type="checkbox"/>	<input type="checkbox"/>	<input type="checkbox"/>	<input type="checkbox"/>	<input type="checkbox"/>
	72"	VOLTLS72	<input type="checkbox"/>	<input type="checkbox"/>	<input type="checkbox"/>	<input type="checkbox"/>	<input type="checkbox"/>	<input type="checkbox"/>
	Left Length x Right Length							
 <p><b>Transaction Counter Low Height Corner</b></p> <ul style="list-style-type: none"> <li>Consists of a top, three stanchions, steel privacy panels, and all required assembly hardware</li> <li>Top of transaction surface is approximately 34" from floor</li> <li>Space below transaction surface = 3 3/4"</li> </ul>	42 x 42"	VOLTLC4242	<input type="checkbox"/>	<input type="checkbox"/>	<input type="checkbox"/>	<input type="checkbox"/>	<input type="checkbox"/>	<input type="checkbox"/>
	48 x 48"	VOLTLC4848	<input type="checkbox"/>	<input type="checkbox"/>	<input type="checkbox"/>	<input type="checkbox"/>	<input type="checkbox"/>	<input type="checkbox"/>
	48 x 60"	VOLTLC4860	<input type="checkbox"/>	<input type="checkbox"/>	<input type="checkbox"/>	<input type="checkbox"/>	<input type="checkbox"/>	<input type="checkbox"/>
	48 x 66"	VOLTLC4866	<input type="checkbox"/>	<input type="checkbox"/>	<input type="checkbox"/>	<input type="checkbox"/>	<input type="checkbox"/>	<input type="checkbox"/>
	48 x 72"	VOLTLC4872	<input type="checkbox"/>	<input type="checkbox"/>	<input type="checkbox"/>	<input type="checkbox"/>	<input type="checkbox"/>	<input type="checkbox"/>
	60 x 48"	VOLTLC6048	<input type="checkbox"/>	<input type="checkbox"/>	<input type="checkbox"/>	<input type="checkbox"/>	<input type="checkbox"/>	<input type="checkbox"/>
	66 x 48"	VOLTLC6648	<input type="checkbox"/>	<input type="checkbox"/>	<input type="checkbox"/>	<input type="checkbox"/>	<input type="checkbox"/>	<input type="checkbox"/>
	72 x 48"	VOLTLC7248	<input type="checkbox"/>	<input type="checkbox"/>	<input type="checkbox"/>	<input type="checkbox"/>	<input type="checkbox"/>	<input type="checkbox"/>

A
B
B
C
D
E

OPTIONAL

### HOW TO ORDER

Indicate the following information on order form:

- Quantity of each item.
- Model Number, including options. See "How to Build a Model Number".
- Any special service required.

- Note:
- The  indicates that a choice is required.
  - The absence of the  indicates that no choice is required.
  - Alpha-numeric characters in place of  indicate that no other alternatives are available.

### HOW TO BUILD A MODEL NUMBER

- A** Select size of worksurface (left to right).
- B** Select edge style.
  - 3L** = PVC edge
  - WL** = Wood edge\*

\*If WL is selected, see the color selection chart for wood edge designators on pg. 6.
- C** Select trim color (3L edge and stanchion cover).
  - BL** = Black
  - GR** = Grey
  - LG** = Light Tone
  - SA** = Sand
  - WG** = Warm Grey
- D** Select paint color. (Stanchions and below surface panel). See pages 6-9 for color addendum.
- E** Select laminate surface. See pages 6-9 for color addendum.

Specifications are subject to change without prior notice.

### INFORMATION

Transaction surfaces must be used above a desk of the same size.



# Volition Desks

## Executive Desks

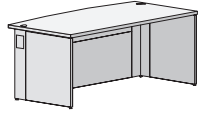

### MODEL

#### Executive Desk

- Consists of a top, two legs, full modesty panel, and standard depth end panels
- Each leg has two cable access grommet locations
- Top has two cable access grommets above the legs
- Modesty panel allows for optional 10-wire electrical system (see pages 31-32)
- "Guest" side of desk has a 6" deep bowed overhang worksurface edge

D x L	MODEL NUMBER								
	Worksurface	Modesty Panel	End Panel	Edge Style	WL Color (Optional)	Trim Color	Paint Color	Laminate	
<b>24 x 60"</b>	VOLED2460	F	S	<input type="checkbox"/>	<input type="checkbox"/>	<input type="checkbox"/>	<input type="checkbox"/>	<input type="checkbox"/>	
<b>24 x 66"</b>	VOLED2466	F	S	<input type="checkbox"/>	<input type="checkbox"/>	<input type="checkbox"/>	<input type="checkbox"/>	<input type="checkbox"/>	
<b>24 x 72"</b>	VOLED2472	F	S	<input type="checkbox"/>	<input type="checkbox"/>	<input type="checkbox"/>	<input type="checkbox"/>	<input type="checkbox"/>	
<b>30 x 60"</b>	VOLED3060	F	S	<input type="checkbox"/>	<input type="checkbox"/>	<input type="checkbox"/>	<input type="checkbox"/>	<input type="checkbox"/>	
<b>30 x 66"</b>	VOLED3066	F	S	<input type="checkbox"/>	<input type="checkbox"/>	<input type="checkbox"/>	<input type="checkbox"/>	<input type="checkbox"/>	
<b>30 x 72"</b>	VOLED3072	F	S	<input type="checkbox"/>	<input type="checkbox"/>	<input type="checkbox"/>	<input type="checkbox"/>	<input type="checkbox"/>	
		<b>A</b>	<b>B</b>	<b>C</b>	<b>D</b>	<b>D</b> OPTIONAL	<b>E</b>	<b>F</b>	<b>G</b>

### HOW TO ORDER

Indicate the following information on order form:

1. Quantity of each item.
2. Model Number, including options.  
See "How to Build a Model Number".
3. Any special service required.

- Note:
- The  indicates that a choice is required.
  - The absence of the  indicates that no choice is required.
  - Alpha-numeric characters in place of  indicate that no other alternatives are available.

### HOW TO BUILD A MODEL NUMBER

- A** Select size of worksurface. \_\_\_\_\_
- B** Modesty panel. \_\_\_\_\_  
**F** = Full
- C** End panel. \_\_\_\_\_  
**S** = Standard
- D** Select edge style. \_\_\_\_\_  
**3L** = PVC edge  
**WL** = Wood edge\*  
\*If WL is selected, see the color selection chart for wood edge designators on pg. 6.
- E** Select trim color (3L edge and grommets). \_\_\_\_\_  
**BL** = Black  
**GR** = Grey  
**LG** = Light Tone  
**SA** = Sand  
**WG** = Warm Grey
- F** Select paint color. \_\_\_\_\_  
See pages 6-9 for color addendum.
- G** Select laminate surface. \_\_\_\_\_  
See pages 6-9 for color addendum.

Specifications are subject to change without prior notice.

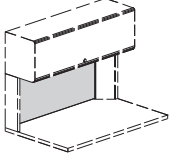
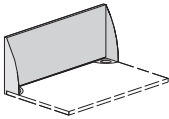
MODEL	H x W	MODEL NUMBER				
		Privacy Screen	Frame Options	Paint Color	Screen Fabric	
 <p><b>Between Stanchion Mounted Screen</b></p> <ul style="list-style-type: none"> <li>Mounts above the worksurface mounted from the stanchions used to support any overhead storage unit</li> <li>Available in:           <ul style="list-style-type: none"> <li>completely upholstered (upholstered frame)</li> <li>exposed frame (core upholstered, frame painted)</li> <li>translucent (core is translucent, frame painted)</li> </ul> </li> <li>Includes screen and all required mounting hardware</li> <li>"W" size refers to the desk size screen is mounted on (not the distance between stanchions)</li> </ul>	19 x 24"	VOLSBS1924	<input type="checkbox"/>	<input type="checkbox"/>	<input type="checkbox"/>	<input type="checkbox"/>
	19 x 30"	VOLSBS1930	<input type="checkbox"/>	<input type="checkbox"/>	<input type="checkbox"/>	<input type="checkbox"/>
	19 x 36"	VOLSBS1936	<input type="checkbox"/>	<input type="checkbox"/>	<input type="checkbox"/>	<input type="checkbox"/>
	19 x 42"	VOLSBS1942	<input type="checkbox"/>	<input type="checkbox"/>	<input type="checkbox"/>	<input type="checkbox"/>
	19 x 48"	VOLSBS1948	<input type="checkbox"/>	<input type="checkbox"/>	<input type="checkbox"/>	<input type="checkbox"/>
	19 x 54"	VOLSBS1954	<input type="checkbox"/>	<input type="checkbox"/>	<input type="checkbox"/>	<input type="checkbox"/>
	19 x 60"	VOLSBS1960	<input type="checkbox"/>	<input type="checkbox"/>	<input type="checkbox"/>	<input type="checkbox"/>
	19 x 66"	VOLSBS1966	<input type="checkbox"/>	<input type="checkbox"/>	<input type="checkbox"/>	<input type="checkbox"/>
	19 x 72"	VOLSBS1972	<input type="checkbox"/>	<input type="checkbox"/>	<input type="checkbox"/>	<input type="checkbox"/>
	 <p><b>Behind Worksurface Mounted Screen</b></p> <ul style="list-style-type: none"> <li>Mounts behind the back edge of the worksurface on brackets that attach through the grommets of the worksurface</li> <li>Available in:           <ul style="list-style-type: none"> <li>completely upholstered (upholstered frame)</li> <li>exposed frame (core upholstered, frame painted)</li> <li>translucent (core is translucent, frame painted)</li> </ul> </li> <li>Includes screen and all required mounting hardware</li> <li>"W" size refers to the desk size screen is mounted on</li> <li>Available in two heights:           <ul style="list-style-type: none"> <li>20" matches the height of a stanchion mounted screen</li> <li>38" matches the height of an overhead storage unit</li> </ul> </li> <li>66" and 72" SBW screens are made up of two smaller screens</li> </ul>	20 x 24"	VOLSBW2024	<input type="checkbox"/>	<input type="checkbox"/>	<input type="checkbox"/>
20 x 30"		VOLSBW2030	<input type="checkbox"/>	<input type="checkbox"/>	<input type="checkbox"/>	<input type="checkbox"/>
20 x 36"		VOLSBW2036	<input type="checkbox"/>	<input type="checkbox"/>	<input type="checkbox"/>	<input type="checkbox"/>
20 x 42"		VOLSBW2042	<input type="checkbox"/>	<input type="checkbox"/>	<input type="checkbox"/>	<input type="checkbox"/>
20 x 48"		VOLSBW2048	<input type="checkbox"/>	<input type="checkbox"/>	<input type="checkbox"/>	<input type="checkbox"/>
20 x 54"		VOLSBW2054	<input type="checkbox"/>	<input type="checkbox"/>	<input type="checkbox"/>	<input type="checkbox"/>
20 x 60"		VOLSBW2060	<input type="checkbox"/>	<input type="checkbox"/>	<input type="checkbox"/>	<input type="checkbox"/>
20 x 66"		VOLSBW2066	<input type="checkbox"/>	<input type="checkbox"/>	<input type="checkbox"/>	<input type="checkbox"/>
20 x 72"		VOLSBW2072	<input type="checkbox"/>	<input type="checkbox"/>	<input type="checkbox"/>	<input type="checkbox"/>
38 x 24"		VOLSBW3824	<input type="checkbox"/>	<input type="checkbox"/>	<input type="checkbox"/>	<input type="checkbox"/>
38 x 30"		VOLSBW3830	<input type="checkbox"/>	<input type="checkbox"/>	<input type="checkbox"/>	<input type="checkbox"/>
38 x 36"		VOLSBW3836	<input type="checkbox"/>	<input type="checkbox"/>	<input type="checkbox"/>	<input type="checkbox"/>
38 x 42"		VOLSBW3842	<input type="checkbox"/>	<input type="checkbox"/>	<input type="checkbox"/>	<input type="checkbox"/>
38 x 48"		VOLSBW3848	<input type="checkbox"/>	<input type="checkbox"/>	<input type="checkbox"/>	<input type="checkbox"/>
38 x 54"		VOLSBW3854	<input type="checkbox"/>	<input type="checkbox"/>	<input type="checkbox"/>	<input type="checkbox"/>
38 x 60"		VOLSBW3860	<input type="checkbox"/>	<input type="checkbox"/>	<input type="checkbox"/>	<input type="checkbox"/>
38 x 66"		VOLSBW3866	<input type="checkbox"/>	<input type="checkbox"/>	<input type="checkbox"/>	<input type="checkbox"/>
38 x 72"		VOLSBW3872	<input type="checkbox"/>	<input type="checkbox"/>	<input type="checkbox"/>	<input type="checkbox"/>

A
B
C
D

## HOW TO ORDER

Indicate the following information on order form:

- Quantity of each item.
- Model Number, including options.  
See "How to Build a Model Number".
- Any special service required.

Note:

- The  indicates that a choice is required.
- The absence of the  indicates that no choice is required.
- Alpha-numeric characters in place of  indicate that no other alternatives are available.

## HOW TO BUILD A MODEL NUMBER

- A** Select privacy screen size.
- B** Select frame options.
- UF** = Upholstered frame  
**EF** = Exposed frame  
**TF** = Translucent
- C** Select paint color.  
 See pages 6-9 for color addendum.
- D** Select screen fabric.

Specifications are subject to change without prior notice.

# Volition Components

## Privacy Screens

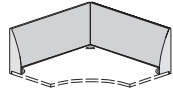

### MODEL

#### Behind Worksurface Mounted Corner Screen

- Mounts behind the back edge of the worksurface on brackets that attach through the grommets on the worksurface
- Available in:
  - completely upholstered (upholstered frame)
  - exposed frame (core upholstered, frame painted)
  - translucent (core is translucent, frame painted)
- Includes screen and all required mounting hardware
- "W" size refers to the desk size screen is mounted on
- Available in two heights:
  - 20" matches the height of a stanchion mounted screen
  - 38" matches the height of an overhead storage unit
- 66" and 72" SBWC screens are made up of two smaller screens

MODEL	Left H x Length x Length	Right H x Length	MODEL NUMBER			
			Privacy Screen	Frame Options	Paint Color	Screen Fabric
	<b>20 x 42 x 42"</b>		VOLSBWC204242	<input type="checkbox"/>	<input type="checkbox"/>	<input type="checkbox"/> <input type="checkbox"/> <input type="checkbox"/> <input type="checkbox"/>
	<b>20 x 48 x 48"</b>		VOLSBWC204848	<input type="checkbox"/>	<input type="checkbox"/>	<input type="checkbox"/> <input type="checkbox"/> <input type="checkbox"/> <input type="checkbox"/>
	<b>20 x 48 x 60"</b>		VOLSBWC204860	<input type="checkbox"/>	<input type="checkbox"/>	<input type="checkbox"/> <input type="checkbox"/> <input type="checkbox"/> <input type="checkbox"/>
	<b>*20 x 48 x 66"</b>		VOLSBWC204866	<input type="checkbox"/>	<input type="checkbox"/>	<input type="checkbox"/> <input type="checkbox"/> <input type="checkbox"/> <input type="checkbox"/>
	<b>**20 x 48 x 72"</b>		VOLSBWC204872	<input type="checkbox"/>	<input type="checkbox"/>	<input type="checkbox"/> <input type="checkbox"/> <input type="checkbox"/> <input type="checkbox"/>
	<b>20 x 60 x 48"</b>		VOLSBWC206048	<input type="checkbox"/>	<input type="checkbox"/>	<input type="checkbox"/> <input type="checkbox"/> <input type="checkbox"/> <input type="checkbox"/>
	<b>*20 x 66 x 48"</b>		VOLSBWC206648	<input type="checkbox"/>	<input type="checkbox"/>	<input type="checkbox"/> <input type="checkbox"/> <input type="checkbox"/> <input type="checkbox"/>
	<b>**20 x 72 x 48"</b>		VOLSBWC207248	<input type="checkbox"/>	<input type="checkbox"/>	<input type="checkbox"/> <input type="checkbox"/> <input type="checkbox"/> <input type="checkbox"/>
	<b>38 x 42 x 42"</b>		VOLSBWC384242	<input type="checkbox"/>	<input type="checkbox"/>	<input type="checkbox"/> <input type="checkbox"/> <input type="checkbox"/> <input type="checkbox"/>
	<b>38 x 48 x 48"</b>		VOLSBWC384848	<input type="checkbox"/>	<input type="checkbox"/>	<input type="checkbox"/> <input type="checkbox"/> <input type="checkbox"/> <input type="checkbox"/>
	<b>38 x 48 x 60"</b>		VOLSBWC384860	<input type="checkbox"/>	<input type="checkbox"/>	<input type="checkbox"/> <input type="checkbox"/> <input type="checkbox"/> <input type="checkbox"/>
	<b>*38 x 48 x 66"</b>		VOLSBWC384866	<input type="checkbox"/>	<input type="checkbox"/>	<input type="checkbox"/> <input type="checkbox"/> <input type="checkbox"/> <input type="checkbox"/>
	<b>**38 x 48 x 72"</b>		VOLSBWC384872	<input type="checkbox"/>	<input type="checkbox"/>	<input type="checkbox"/> <input type="checkbox"/> <input type="checkbox"/> <input type="checkbox"/>
	<b>38 x 60 x 48"</b>		VOLSBWC386048	<input type="checkbox"/>	<input type="checkbox"/>	<input type="checkbox"/> <input type="checkbox"/> <input type="checkbox"/> <input type="checkbox"/>
	<b>*38 x 66 x 48"</b>		VOLSBWC386648	<input type="checkbox"/>	<input type="checkbox"/>	<input type="checkbox"/> <input type="checkbox"/> <input type="checkbox"/> <input type="checkbox"/>
	<b>**38 x 72 x 48"</b>		VOLSBWC387248	<input type="checkbox"/>	<input type="checkbox"/>	<input type="checkbox"/> <input type="checkbox"/> <input type="checkbox"/> <input type="checkbox"/>

A

B

C

D

### HOW TO ORDER

Indicate the following information on order form:

1. Quantity of each item.
2. Model Number, including options.  
See "How to Build a Model Number".
3. Any special service required.

- Note:
- The  indicates that a choice is required.
  - The absence of the  indicates that no choice is required.
  - Alpha-numeric characters in place of  indicate that no other alternatives are available.

### HOW TO BUILD A MODEL NUMBER

- A** Select privacy screen size.
- B** Select frame options.
- UF** = Upholstered frame  
**EF** = Exposed frame  
**TF** = Translucent
- C** Select paint color.  
See pages 6-9 for color addendum.
- D** Select screen fabric.

Specifications are subject to change without prior notice.

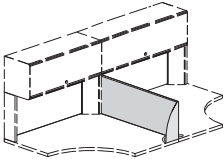
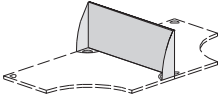
MODEL	H x W	MODEL NUMBER							
		Privacy Screen	Bracket Direction	Frame Options	Paint Color	Screen Fabric			
 <p><b>Stanchion and On-Worksurface Mounted Screen (between a stanchion and an end mount bracket)</b></p> <ul style="list-style-type: none"> <li>Mounts on the worksurface between a stanchion used to support any overhead storage unit and an end mount bracket</li> <li>Available in:           <ul style="list-style-type: none"> <li>completely upholstered (upholstered frame)</li> <li>exposed frame (core upholstered, frame painted)</li> <li>translucent (core is translucent, frame painted)</li> </ul> </li> <li>Includes screen and all required mounting hardware</li> <li>"W" size refers to the desk size screen is mounted on (not the distance between the stanchion and the bracket)</li> <li>Available in a 19" height to match a between stanchion mounted screen</li> <li>72" SSO screen is made up of two smaller screens</li> </ul>	19 x 24"	VOLSSO1924	<input type="checkbox"/>	<input type="checkbox"/>	<input type="checkbox"/>	<input type="checkbox"/>	<input type="checkbox"/>	<input type="checkbox"/>	<input type="checkbox"/>
	19 x 30"	VOLSSO1930	<input type="checkbox"/>	<input type="checkbox"/>	<input type="checkbox"/>	<input type="checkbox"/>	<input type="checkbox"/>	<input type="checkbox"/>	<input type="checkbox"/>
	19 x 36"	VOLSSO1936	<input type="checkbox"/>	<input type="checkbox"/>	<input type="checkbox"/>	<input type="checkbox"/>	<input type="checkbox"/>	<input type="checkbox"/>	<input type="checkbox"/>
	19 x 42"	VOLSSO1942	<input type="checkbox"/>	<input type="checkbox"/>	<input type="checkbox"/>	<input type="checkbox"/>	<input type="checkbox"/>	<input type="checkbox"/>	<input type="checkbox"/>
	19 x 48"	VOLSSO1948	<input type="checkbox"/>	<input type="checkbox"/>	<input type="checkbox"/>	<input type="checkbox"/>	<input type="checkbox"/>	<input type="checkbox"/>	<input type="checkbox"/>
	19 x 54"	VOLSSO1954	<input type="checkbox"/>	<input type="checkbox"/>	<input type="checkbox"/>	<input type="checkbox"/>	<input type="checkbox"/>	<input type="checkbox"/>	<input type="checkbox"/>
	19 x 60"	VOLSSO1960	<input type="checkbox"/>	<input type="checkbox"/>	<input type="checkbox"/>	<input type="checkbox"/>	<input type="checkbox"/>	<input type="checkbox"/>	<input type="checkbox"/>
	19 x 66"	VOLSSO1966	<input type="checkbox"/>	<input type="checkbox"/>	<input type="checkbox"/>	<input type="checkbox"/>	<input type="checkbox"/>	<input type="checkbox"/>	<input type="checkbox"/>
	19 x 72"	VOLSSO1972	<input type="checkbox"/>	<input type="checkbox"/>	<input type="checkbox"/>	<input type="checkbox"/>	<input type="checkbox"/>	<input type="checkbox"/>	<input type="checkbox"/>
	 <p><b>On-Worksurface Mounted Screen (between two end mount brackets)</b></p> <ul style="list-style-type: none"> <li>Mounts on the worksurface between two end mount brackets</li> <li>Available in:           <ul style="list-style-type: none"> <li>completely upholstered (upholstered frame)</li> <li>exposed frame (core upholstered, frame painted)</li> <li>translucent (core is translucent, frame painted)</li> </ul> </li> <li>Includes screen and all required mounting hardware</li> <li>"W" size refers to the desk size screen is mounted on</li> <li>Available in two heights:           <ul style="list-style-type: none"> <li>19" matches the height of a stanchion mounted screen</li> <li>37" matches the height of an overhead storage unit</li> </ul> </li> <li>66" and 72" SOW screens are made up of two smaller screens</li> </ul>	19 x 24"	VOLSOW1924		<input type="checkbox"/>	<input type="checkbox"/>	<input type="checkbox"/>	<input type="checkbox"/>	<input type="checkbox"/>
19 x 30"		VOLSOW1930		<input type="checkbox"/>	<input type="checkbox"/>	<input type="checkbox"/>	<input type="checkbox"/>	<input type="checkbox"/>	
19 x 36"		VOLSOW1936		<input type="checkbox"/>	<input type="checkbox"/>	<input type="checkbox"/>	<input type="checkbox"/>	<input type="checkbox"/>	
19 x 42"		VOLSOW1942		<input type="checkbox"/>	<input type="checkbox"/>	<input type="checkbox"/>	<input type="checkbox"/>	<input type="checkbox"/>	
19 x 48"		VOLSOW1948		<input type="checkbox"/>	<input type="checkbox"/>	<input type="checkbox"/>	<input type="checkbox"/>	<input type="checkbox"/>	
19 x 54"		VOLSOW1954		<input type="checkbox"/>	<input type="checkbox"/>	<input type="checkbox"/>	<input type="checkbox"/>	<input type="checkbox"/>	
19 x 60"		VOLSOW1960		<input type="checkbox"/>	<input type="checkbox"/>	<input type="checkbox"/>	<input type="checkbox"/>	<input type="checkbox"/>	
19 x 66"		VOLSOW1966		<input type="checkbox"/>	<input type="checkbox"/>	<input type="checkbox"/>	<input type="checkbox"/>	<input type="checkbox"/>	
19 x 72"		VOLSOW1972		<input type="checkbox"/>	<input type="checkbox"/>	<input type="checkbox"/>	<input type="checkbox"/>	<input type="checkbox"/>	
37 x 24"		VOLSOW3724		<input type="checkbox"/>	<input type="checkbox"/>	<input type="checkbox"/>	<input type="checkbox"/>	<input type="checkbox"/>	
37 x 30"		VOLSOW3730		<input type="checkbox"/>	<input type="checkbox"/>	<input type="checkbox"/>	<input type="checkbox"/>	<input type="checkbox"/>	
37 x 36"		VOLSOW3736		<input type="checkbox"/>	<input type="checkbox"/>	<input type="checkbox"/>	<input type="checkbox"/>	<input type="checkbox"/>	
37 x 42"		VOLSOW3742		<input type="checkbox"/>	<input type="checkbox"/>	<input type="checkbox"/>	<input type="checkbox"/>	<input type="checkbox"/>	
37 x 48"		VOLSOW3748		<input type="checkbox"/>	<input type="checkbox"/>	<input type="checkbox"/>	<input type="checkbox"/>	<input type="checkbox"/>	
37 x 54"		VOLSOW3754		<input type="checkbox"/>	<input type="checkbox"/>	<input type="checkbox"/>	<input type="checkbox"/>	<input type="checkbox"/>	
37 x 60"	VOLSOW3760		<input type="checkbox"/>	<input type="checkbox"/>	<input type="checkbox"/>	<input type="checkbox"/>	<input type="checkbox"/>		
37 x 66"	VOLSOW3766		<input type="checkbox"/>	<input type="checkbox"/>	<input type="checkbox"/>	<input type="checkbox"/>	<input type="checkbox"/>		
37 x 72"	VOLSOW3772		<input type="checkbox"/>	<input type="checkbox"/>	<input type="checkbox"/>	<input type="checkbox"/>	<input type="checkbox"/>		

A

B

C

D

E

## HOW TO ORDER

Indicate the following information on order form:

- Quantity of each item.
- Model Number, including options.  
See "How to Build a Model Number".
- Any special service required.

- Note:
- The  indicates that a choice is required.
  - The absence of the  indicates that no choice is required.
  - Alpha-numeric characters in place of  indicate that no other alternatives are available.

## HOW TO BUILD A MODEL NUMBER

- A** Select privacy screen size.
- B** Select bracket direction (if required).  
**L** = Left  
**R** = Right
- C** Select frame options.  
**UF** = Upholstered frame  
**EF** = Exposed frame  
**TF** = Translucent
- D** Select paint color.  
See pages 6-9 for color addendum.
- E** Select screen fabric.

Specifications are subject to change without prior notice.

# Volition Components

## Privacy Screens

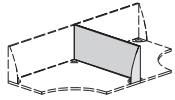

\*Right shown.

### MODEL

### H x W

### MODEL NUMBER

Privacy Screen

Direction

Frame Options

Paint Color

Screen Fabric

### On-Worksurface Mounted Corner Screen

- Mounts along the back edge of a corner worksurface and is supported by an end mount bracket, and a bracket that attaches it to a SBW screen
- Available in:
  - completely upholstered (upholstered frame)
  - exposed frame (core upholstered, frame painted)
  - translucent (core is translucent, frame painted)
- Includes screen and all required mounting hardware
- "W" size refers to the desk size screen is mounted on
- Available in two heights:
  - 19" matches the height of a stanchion mounted screen
  - 37" matches the height of an overhead storage unit
- 66" and 72" SOWC screens are made up of two smaller screens
- Direction determined by the end mount bracket used

19 x 42"

VOLSOWC1942

19 x 48"

VOLSOWC1948

19 x 60"

VOLSOWC1960

\*19 x 66"

VOLSOWC1966

\*\*19 x 72"

VOLSOWC1972

37 x 42"

VOLSOWC3742

37 x 48"

VOLSOWC3748

37 x 60"

VOLSOWC3760

\*37 x 66"

VOLSOWC3766

\*\*37 x 72"

VOLSOWC3772

A

B

C

D

E

### HOW TO ORDER

Indicate the following information on order form:

1. Quantity of each item.
2. Model Number, including options.  
See "How to Build a Model Number".
3. Any special service required.

- Note:
- The  indicates that a choice is required.
  - The absence of the  indicates that no choice is required.
  - Alpha-numeric characters in place of  indicate that no other alternatives are available.

### HOW TO BUILD A MODEL NUMBER

**A** Select privacy screen size.

**B** Select bracket direction.

**L** = Left

**R** = Right

**C** Select frame options.

**UF** = Upholstered frame

**EF** = Exposed frame

**TF** = Translucent

**D** Select paint color.

See pages 6-9 for color addendum.

**E** Select screen fabric.

### INFORMATION

#### Note:

The model number will relate to the size of the desk it is being mounted on.

\*66" screens are made up of a separate 30" and 36" screen, a dovetail splice mechanism and mounting hardware.

\*\*72" screens are made up of two separate 36" screens, a dovetail splice mechanism and mounting hardware.

Specifications are subject to change without prior notice.

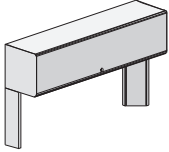
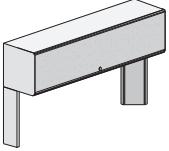
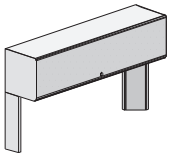
MODEL	Size	MODEL NUMBER				
		Overhead	Trim Color	Cabinet & Door Color	Door Fabric	Door Laminate
 <p><b>Universal Overhead with Painted Steel Door</b></p> <ul style="list-style-type: none"> <li>• Steel bottom and top shelf, end panels, full back and door front with powder coat finish</li> <li>• Door recedes inside the cabinet with exposed handle</li> <li>• Includes the overhead cabinet, two (or three on 66" and 72") stanchions, and all required assembly hardware</li> <li>• 66" includes one 36" unit and one 30" unit</li> <li>• 72" includes two 36" units</li> <li>• Shelf dividers (NSD) available separately (see below)</li> <li>• Overhead must attach to a desk of the same size</li> </ul>	24"	PRDS24VL	<input type="checkbox"/>	<input type="checkbox"/>		
	30"	PRDS30VL	<input type="checkbox"/>	<input type="checkbox"/>		
	36"	PRDS36VL	<input type="checkbox"/>	<input type="checkbox"/>		
	42"	PRDS42VL	<input type="checkbox"/>	<input type="checkbox"/>		
	48"	PRDS48VL	<input type="checkbox"/>	<input type="checkbox"/>		
	54"	PRDS54VL	<input type="checkbox"/>	<input type="checkbox"/>		
	60"	PRDS60VL	<input type="checkbox"/>	<input type="checkbox"/>		
	66"	PRDS66VL	<input type="checkbox"/>	<input type="checkbox"/>		
	72"	PRDS72VL	<input type="checkbox"/>	<input type="checkbox"/>		
	 <p><b>Universal Overhead with Fabric Covered Door</b></p> <ul style="list-style-type: none"> <li>• Steel bottom and top shelf, end panels, full back and fabric covered steel door with powder coat finish</li> <li>• Door recedes inside the cabinet with exposed handle</li> <li>• Includes the overhead cabinet, two (or three on 66" and 72") stanchions, and all required assembly hardware</li> <li>• 66" includes one 36" unit and one 30" unit</li> <li>• 72" includes two 36" units</li> <li>• Shelf dividers (NSD) available separately (see below)</li> <li>• Overhead must attach to a desk of the same size</li> </ul>	24"	PRDF24VL	<input type="checkbox"/>	<input type="checkbox"/>	<input type="checkbox"/>
30"		PRDF30VL	<input type="checkbox"/>	<input type="checkbox"/>	<input type="checkbox"/>	<input type="checkbox"/>
36"		PRDF36VL	<input type="checkbox"/>	<input type="checkbox"/>	<input type="checkbox"/>	<input type="checkbox"/>
42"		PRDF42VL	<input type="checkbox"/>	<input type="checkbox"/>	<input type="checkbox"/>	<input type="checkbox"/>
48"		PRDF48VL	<input type="checkbox"/>	<input type="checkbox"/>	<input type="checkbox"/>	<input type="checkbox"/>
54"		PRDF54VL	<input type="checkbox"/>	<input type="checkbox"/>	<input type="checkbox"/>	<input type="checkbox"/>
60"		PRDF60VL	<input type="checkbox"/>	<input type="checkbox"/>	<input type="checkbox"/>	<input type="checkbox"/>
66"		PRDF66VL	<input type="checkbox"/>	<input type="checkbox"/>	<input type="checkbox"/>	<input type="checkbox"/>
72"		PRDF72VL	<input type="checkbox"/>	<input type="checkbox"/>	<input type="checkbox"/>	<input type="checkbox"/>
 <p><b>Universal Overhead with Laminate Covered Door</b></p> <ul style="list-style-type: none"> <li>• Steel bottom and top shelf, end panels, full back with powder coat finish, and laminate covered particle board door</li> <li>• Door recedes inside the cabinet with exposed handle</li> <li>• Includes the overhead cabinet, two (or three on 66" and 72") stanchions, and all required assembly hardware</li> <li>• 66" includes one 36" unit and one 30" unit</li> <li>• 72" includes two 36" units</li> <li>• Shelf dividers (NSD) available separately (see below)</li> <li>• Overhead must attach to a desk of the same size</li> </ul>		24"	PRDL24VL	<input type="checkbox"/>	<input type="checkbox"/>	
	30"	PRDL30VL	<input type="checkbox"/>	<input type="checkbox"/>		<input type="checkbox"/>
	36"	PRDL36VL	<input type="checkbox"/>	<input type="checkbox"/>		<input type="checkbox"/>
	42"	PRDL42VL	<input type="checkbox"/>	<input type="checkbox"/>		<input type="checkbox"/>
	48"	PRDL48VL	<input type="checkbox"/>	<input type="checkbox"/>		<input type="checkbox"/>
	54"	PRDL54VL	<input type="checkbox"/>	<input type="checkbox"/>		<input type="checkbox"/>
	60"	PRDL60VL	<input type="checkbox"/>	<input type="checkbox"/>		<input type="checkbox"/>
	66"	PRDL66VL	<input type="checkbox"/>	<input type="checkbox"/>		<input type="checkbox"/>
	72"	PRDL72VL	<input type="checkbox"/>	<input type="checkbox"/>		<input type="checkbox"/>
	<b>Shelf Divider</b>		NSD	<input type="checkbox"/>		

A
B
C
D
E

### HOW TO ORDER

Indicate the following information on order form:

1. Quantity of each item.
2. Model Number, including options.  
See "How to Build a Model Number".
3. Any special service required.

- Note:
- The  indicates that a choice is required.
  - The absence of the  indicates that no choice is required.
  - Alpha-numeric characters in place of  indicate that no other alternatives are available.



### HOW TO BUILD A MODEL NUMBER

- A** Select overhead door size.
- B** Select trim color.  
(stanchion cover and door handle).\*
- BL** = Black
- GR** = Grey
- LG** = Light Tone
- SA** = Sand
- WG** = Warm Grey
- \*Trim color matches paint color.
- C** Select cabinet and door color.  
See pages 6-9 for color addendum.
- D** Select door fabric (if required).
- E** Select door laminate (if required).  
See pages 6-9 for color addendum.

Specifications are subject to change without prior notice.

# Volition Components

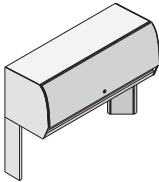
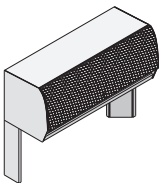
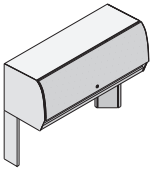
Venus Overhead Storage

MODEL	Size	MODEL NUMBER						
		Basic Model	Trim Color	Cabinet & Stanchion Paint Color	Upper Door Solid Color	Upper Door Fabric	Upper Door Laminate	
 <p><b>Venus Overhead Solid Door</b></p> <ul style="list-style-type: none"> <li>Colored or translucent extruded PVC upper door</li> <li>Painted lower door</li> <li>Includes the overhead cabinet, two stanchions, all required assembly hardware</li> <li>66" has two 33" doors</li> <li>72" has two 36" doors</li> <li>Shelf dividers (NSD) available separately (see below)</li> <li>Overhead must attach to a desk of the same size</li> </ul>	24"	VNOS24VL	<input type="checkbox"/>	<input type="checkbox"/>	<input type="checkbox"/>			
	30"	VNOS30VL	<input type="checkbox"/>	<input type="checkbox"/>	<input type="checkbox"/>			
	36"	VNOS36VL	<input type="checkbox"/>	<input type="checkbox"/>	<input type="checkbox"/>			
	42"	VNOS42VL	<input type="checkbox"/>	<input type="checkbox"/>	<input type="checkbox"/>			
	48"	VNOS48VL	<input type="checkbox"/>	<input type="checkbox"/>	<input type="checkbox"/>			
	54"	VNOS54VL	<input type="checkbox"/>	<input type="checkbox"/>	<input type="checkbox"/>			
	60"	VNOS60VL	<input type="checkbox"/>	<input type="checkbox"/>	<input type="checkbox"/>			
	66"	VNOS66DVL	<input type="checkbox"/>	<input type="checkbox"/>	<input type="checkbox"/>			
72"	VNOS72DVL	<input type="checkbox"/>	<input type="checkbox"/>	<input type="checkbox"/>				
 <p><b>Venus Overhead Fabric Covered Door</b></p> <ul style="list-style-type: none"> <li>Fabric covered PVC upper door</li> <li>Painted lower door</li> <li>Includes the overhead cabinet, two stanchions, all required assembly hardware</li> <li>66" has two 33" doors</li> <li>72" has two 36" doors</li> <li>Shelf dividers (NSD) available separately (see below)</li> <li>Overhead must attach to a desk of the same size</li> </ul>	24"	VNOF24VL	<input type="checkbox"/>	<input type="checkbox"/>	<input type="checkbox"/>			
	30"	VNOF30VL	<input type="checkbox"/>	<input type="checkbox"/>		<input type="checkbox"/>	<input type="checkbox"/>	
	36"	VNOF36VL	<input type="checkbox"/>	<input type="checkbox"/>		<input type="checkbox"/>	<input type="checkbox"/>	
	42"	VNOF42VL	<input type="checkbox"/>	<input type="checkbox"/>		<input type="checkbox"/>	<input type="checkbox"/>	
	48"	VNOF48VL	<input type="checkbox"/>	<input type="checkbox"/>		<input type="checkbox"/>	<input type="checkbox"/>	
	54"	VNOF54VL	<input type="checkbox"/>	<input type="checkbox"/>		<input type="checkbox"/>	<input type="checkbox"/>	
	60"	VNOF60VL	<input type="checkbox"/>	<input type="checkbox"/>		<input type="checkbox"/>	<input type="checkbox"/>	
	66"	VNOF66DVL	<input type="checkbox"/>	<input type="checkbox"/>		<input type="checkbox"/>	<input type="checkbox"/>	
72"	VNOF72DVL	<input type="checkbox"/>	<input type="checkbox"/>		<input type="checkbox"/>	<input type="checkbox"/>		
 <p><b>Venus Overhead Laminate Covered Door</b></p> <ul style="list-style-type: none"> <li>Laminate covered PVC upper door</li> <li>Painted lower door</li> <li>Includes the overhead cabinet, two stanchions, all required assembly hardware</li> <li>66" has two 33" doors</li> <li>72" has two 36" doors</li> <li>Shelf dividers (NSD) available separately (see below)</li> <li>Overhead must attach to a desk of the same size</li> </ul>	24"	VNOL24VL	<input type="checkbox"/>	<input type="checkbox"/>			<input type="checkbox"/>	
	30"	VNOL30VL	<input type="checkbox"/>	<input type="checkbox"/>			<input type="checkbox"/>	
	36"	VNOL36VL	<input type="checkbox"/>	<input type="checkbox"/>			<input type="checkbox"/>	
	42"	VNOL42VL	<input type="checkbox"/>	<input type="checkbox"/>			<input type="checkbox"/>	
	48"	VNOL48VL	<input type="checkbox"/>	<input type="checkbox"/>			<input type="checkbox"/>	
	54"	VNOL54VL	<input type="checkbox"/>	<input type="checkbox"/>			<input type="checkbox"/>	
	60"	VNOL60VL	<input type="checkbox"/>	<input type="checkbox"/>			<input type="checkbox"/>	
	66"	VNOL66DVL	<input type="checkbox"/>	<input type="checkbox"/>			<input type="checkbox"/>	
72"	VNOL72DVL	<input type="checkbox"/>	<input type="checkbox"/>			<input type="checkbox"/>		
<p><b>Venus Overhead Conversion Kit</b></p> <ul style="list-style-type: none"> <li>Kit includes all the parts and hardware required to convert a System XXI or PowerWorks Venus Overhead into a Volition Venus Overhead</li> <li>Overhead must attach to a desk of the same size</li> </ul>	24"	VOLVDCK24	<input type="checkbox"/>	<input type="checkbox"/>				
	30"	VOLVDCK30	<input type="checkbox"/>	<input type="checkbox"/>				
	36"	VOLVDCK36	<input type="checkbox"/>	<input type="checkbox"/>				
	42"	VOLVDCK42	<input type="checkbox"/>	<input type="checkbox"/>				
	48"	VOLVDCK48	<input type="checkbox"/>	<input type="checkbox"/>				
	54"	VOLVDCK54	<input type="checkbox"/>	<input type="checkbox"/>				
	60"	VOLVDCK60	<input type="checkbox"/>	<input type="checkbox"/>				
	66"	VOLVDCK66	<input type="checkbox"/>	<input type="checkbox"/>				
72"	VOLVDCK72	<input type="checkbox"/>	<input type="checkbox"/>					
 <p><b>Shelf Divider</b></p>		NSD	<input type="checkbox"/>					
				<b>A</b>	<b>B</b>	<b>C</b>	<b>D</b>	<b>E</b>

## HOW TO ORDER

Indicate the following information on order form:

- Quantity of each item.
- Model Number, including options. See "How to Build a Model Number".
- Any special service required.

Note:

- The  indicates that a choice is required.
- The absence of the  indicates that no choice is required.
- Alpha-numeric characters in place of  indicate that no other alternatives are available.

## HOW TO BUILD A MODEL NUMBER

**A** Select overhead door size.

**B** Select trim color.

**BL** = Black

**GR** = Grey

**LG** = Light Tone

**SA** = Sand

**WG** = Warm Grey

**C** Select cabinet lower door and stanchion paint color.

See pages 6-9 for color addendum.

**D** Select upper door solid color (if required).

**BL** = Black

**GR** = Grey

**LG** = Light Tone

**SA** = Sand

**WG** = Warm Grey

**TR** = Translucent

**E** Select door fabric (if required).

**F** Select upper door laminate (if required).

See pages 6-9 for color addendum.

Specifications are subject to change without prior notice.

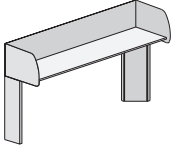
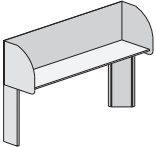
MODEL	Size	MODEL NUMBER		
		Overhead	Trim Color	Cabinet & Stanchion Paint Color
 <p><b>Universal Low Shelf</b></p> <ul style="list-style-type: none"> <li>• Steel bottom shelf, end panels, and full back with powder coat finish</li> <li>• Includes the overhead cabinet, two (or three on 66" and 72") stanchions, and all required assembly hardware</li> <li>• 66" includes one 36" unit and one 30" unit</li> <li>• 72" includes two 36" units</li> <li>• Shelf dividers (NSD) available separately (see below)</li> <li>• Overhead must attach to a desk of the same size</li> </ul>	24"	VOLULSR24	<input type="checkbox"/>	<input type="checkbox"/>
	30"	VOLULSR30	<input type="checkbox"/>	<input type="checkbox"/>
	36"	VOLULSR36	<input type="checkbox"/>	<input type="checkbox"/>
	42"	VOLULSR42	<input type="checkbox"/>	<input type="checkbox"/>
	48"	VOLULSR48	<input type="checkbox"/>	<input type="checkbox"/>
	54"	VOLULSR54	<input type="checkbox"/>	<input type="checkbox"/>
	60"	VOLULSR60	<input type="checkbox"/>	<input type="checkbox"/>
	66"	VOLULSR66	<input type="checkbox"/>	<input type="checkbox"/>
	72"	VOLULSR72	<input type="checkbox"/>	<input type="checkbox"/>
 <p><b>Universal Regular Shelf</b></p> <ul style="list-style-type: none"> <li>• Steel bottom shelf, end panels, and full back with powder coat finish</li> <li>• Includes the overhead cabinet, two (or three on 66" and 72") stanchions, and all required assembly hardware</li> <li>• 66" includes one 36" unit and one 30" unit</li> <li>• 72" includes two 36" units</li> <li>• Shelf dividers (NSD) available separately (see below)</li> <li>• Overhead must attach to a desk of the same size</li> </ul>	24"	VOLURSR24	<input type="checkbox"/>	<input type="checkbox"/>
	30"	VOLURSR30	<input type="checkbox"/>	<input type="checkbox"/>
	36"	VOLURSR36	<input type="checkbox"/>	<input type="checkbox"/>
	42"	VOLURSR42	<input type="checkbox"/>	<input type="checkbox"/>
	48"	VOLURSR48	<input type="checkbox"/>	<input type="checkbox"/>
	54"	VOLURSR54	<input type="checkbox"/>	<input type="checkbox"/>
	60"	VOLURSR60	<input type="checkbox"/>	<input type="checkbox"/>
	66"	VOLURSR66	<input type="checkbox"/>	<input type="checkbox"/>
	72"	VOLURSR72	<input type="checkbox"/>	<input type="checkbox"/>
<p><b>Universal Overhead Conversion Kit</b></p> <ul style="list-style-type: none"> <li>• Kit includes all the parts and hardware required to convert a System XXI or PowerWorks Universal Overhead into a Volition Universal Overhead</li> <li>• Overhead must attach to a desk of the same size</li> </ul>	24"	PRDCK24VL	<input type="checkbox"/>	<input type="checkbox"/>
	30"	PRDCK30VL	<input type="checkbox"/>	<input type="checkbox"/>
	36"	PRDCK36VL	<input type="checkbox"/>	<input type="checkbox"/>
	42"	PRDCK42VL	<input type="checkbox"/>	<input type="checkbox"/>
	48"	PRDCK48VL	<input type="checkbox"/>	<input type="checkbox"/>
	54"	PRDCK54VL	<input type="checkbox"/>	<input type="checkbox"/>
	60"	PRDCK60VL	<input type="checkbox"/>	<input type="checkbox"/>
	66"	PRDCK66VL	<input type="checkbox"/>	<input type="checkbox"/>
72"	PRDCK72VL	<input type="checkbox"/>	<input type="checkbox"/>	
<b>Shelf Divider</b>		NSD	<input type="checkbox"/>	<input type="checkbox"/>

A

B

C

**HOW TO ORDER**

Indicate the following information on order form:

1. Quantity of each item.
2. Model Number, including options.  
See "How to Build a Model Number".
3. Any special service required.

- Note:
- The  indicates that a choice is required.
  - The absence of the  indicates that no choice is required.
  - Alpha-numeric characters in place of  indicate that no other alternatives are available.

**HOW TO BUILD A MODEL NUMBER**

- A** Select overhead size.

- B** Select trim color.

**BL** = Black

**GR** = Grey

**LG** = Light Tone

**SA** = Sand

**WG** = Warm Grey

- C** Select cabinet and stanchion paint color (for conversion kit).

**BL** = Black

**GR** = Grey

**LG** = Light Tone

**SA** = Sand

**WG** = Warm Grey

Specifications are subject to change without prior notice.



# Volition Components

Data/Communication Accessories

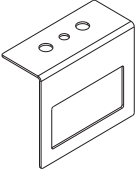
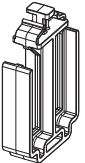
MODEL	Size	MODEL NUMBER		
		Basic Model/Part	Trim Color	Paint Color
 <p><b>Communications Pole</b></p> <ul style="list-style-type: none"> <li>Includes a 7' or 10' aluminum 2-channel power pole and ceiling trim</li> <li>Used to route data/communication cables from a ceiling feed point to the below the worksurface cable channel</li> <li>Attaches to the desk at a corner grommet location</li> </ul>	7 ft.	VOLCOMCP7	<input type="checkbox"/>	<input type="checkbox"/>
	10 ft.	VOLCOMCP10	<input type="checkbox"/>	<input type="checkbox"/>
 <p><b>Face Plate Bracket</b></p> <ul style="list-style-type: none"> <li>Includes a bracket and attachment hardware that allows a TIA/EIA standard faceplate (approximately 1.38" x 2.7" opening) to mount below the desk</li> <li>Face plate and data/communication jacks must be ordered separately</li> </ul>		VOLCOMFB		<input type="checkbox"/>
 <p><b>Cable Support</b></p> <ul style="list-style-type: none"> <li>A plastic hook that attaches to the inside of the modesty panel to assist in the routing of data/communication cables</li> <li>Pack of 25</li> </ul>	Qty.			
	25	460099PCK	BL	
	1	460099	BL	

A

B

C

## HOW TO ORDER

Indicate the following information on order form:

- Quantity of each item.
- Model Number, including options.  
See "How to Build a Model Number".
- Any special service required.

Note:

- The  indicates that a choice is required.
- The absence of the  indicates that no choice is required.
- Alpha-numeric characters in place of  indicate that no other options are available.

## HOW TO BUILD A MODEL NUMBER

- A** Select basic model.
- B** Select trim color (if required).\*
- BL** = Black  
 \_\_\_\_\_  
**GR** = Grey  
 \_\_\_\_\_  
**LG** = Light Tone  
 \_\_\_\_\_  
**SA** = Sand  
 \_\_\_\_\_  
**WG** = Warm Grey  
 \_\_\_\_\_  
 \*Trim color matches paint color.
- C** Select paint color (if required).  
 See pages 6-9 for color addendum.

Specifications are subject to change without prior notice.

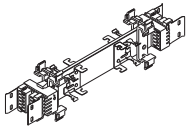
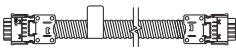
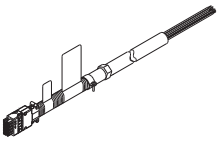
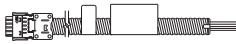
MODEL	Size	MODEL NUMBER			
		6-2-2 Basic Model	4-4-2 Basic Model	Trim Color	Paint Color
 <p><b>Rigid Wireway</b></p> <ul style="list-style-type: none"> <li>Includes rigid wireway electrical harness, steel wireway cover, and all required attachment hardware</li> <li>Available in two 10-wire styles: 6-2-2 (6 circuits) and 4-4-2 (4 circuits). Note: 10-wire styles must match on all electrical parts.</li> <li>Allows two duplex receptacles (ordered separately) to be mounted below the desk worksurface</li> <li>Size must match the desk length. Note: the 72D (dual) provides four possible receptacle locations.</li> </ul>	30"	VOLET6RW30	VOLET4RW30		<input type="checkbox"/> <input type="checkbox"/>
	36"	VOLET6RW36	VOLET4RW36		<input type="checkbox"/> <input type="checkbox"/>
	42"	VOLET6RW42	VOLET4RW42		<input type="checkbox"/> <input type="checkbox"/>
	48"	VOLET6RW48	VOLET4RW48		<input type="checkbox"/> <input type="checkbox"/>
	54"	VOLET6RW54	VOLET4RW54		<input type="checkbox"/> <input type="checkbox"/>
	60"	VOLET6RW60	VOLET4RW60		<input type="checkbox"/> <input type="checkbox"/>
	66"	VOLET6RW66	VOLET4RW66		<input type="checkbox"/> <input type="checkbox"/>
	72"	VOLET6RW72	VOLET4RW72		<input type="checkbox"/> <input type="checkbox"/>
	72"	VOLET6RW72D	VOLET4RW72D		<input type="checkbox"/> <input type="checkbox"/>
	 <p><b>Desk Jumper</b></p> <ul style="list-style-type: none"> <li>Includes jumper harness to make the electrical connection between adjacent desks</li> <li>See specifications for length that must be specified</li> <li>Available in two 10-wire styles: 6-2-2 (6 circuits) and 4-4-2 (4 circuits). Note: 10-wire styles must match on all electrical parts.</li> </ul>	Std	VOLET6DJST	VOLET4DJST	
24"		VOLET6DJ24	VOLET4DJ24		
30"		VOLET6DJ30	VOLET4DJ30		
 <p><b>Base Feed</b></p> <ul style="list-style-type: none"> <li>Includes base feed harness with 6' of colored liquid tite conduit covering. Used to feed power from a hard wired J-box or floor monument to the rigid wireway on a desk.</li> <li>Available in two 10-wire styles: 6-2-2 (6 circuits) and 4-4-2 (4 circuits). Note: 10-wire styles must match on all electrical parts.</li> <li>Building connection hardware must be supplied by customer</li> <li>Paint color on leg cover</li> </ul>		VOLET6BF6	VOLET4BF6	<input type="checkbox"/> <input type="checkbox"/>	<input type="checkbox"/> <input type="checkbox"/>
 <p><b>Top Feed</b></p> <ul style="list-style-type: none"> <li>Includes electrical harness (144" or 216"), aluminum 2-channel power pole (7" or 10" respectively) and ceiling trim</li> <li>Used to feed power from a hard wired J-box above a false ceiling to the rigid wireway or a desk</li> <li>Attaches to the desk at a corner grommet location</li> <li>Available in two 10-wire styles: 6-2-2 (6 circuits) and 4-4-2 (4 circuits). Note: 10-wire styles must match on all electrical parts.</li> <li>Building connection hardware must be supplied by customer</li> </ul>		VOLET6TF144	VOLET4TF144	<input type="checkbox"/> <input type="checkbox"/>	<input type="checkbox"/> <input type="checkbox"/>
		VOLET6TF216	VOLET4TF216	<input type="checkbox"/> <input type="checkbox"/>	<input type="checkbox"/> <input type="checkbox"/>
		A	A	B	C

## HOW TO ORDER

Indicate the following information on order form:

- Quantity of each item.
- Model Number, including options.  
See "How to Build a Model Number".
- Any special service required.

- Note:
- The  indicates that a choice is required.
  - The absence of the  indicates that no choice is required.
  - Alpha-numeric characters in place of  indicate that no other options are available.

## HOW TO BUILD A MODEL NUMBER

**A** Select basic model.

**B** Select trim color (if required).\*

**BL** = Black

**GR** = Grey

**LG** = Light Tone

**SA** = Sand

**WG** = Warm Grey

\*Trim color matches paint color.



**C** Select paint color (if required).

See pages 6-9 for color addendum.

Specifications are subject to change without prior notice.

# Volition Components

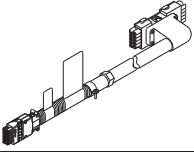
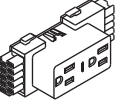
## Electrical

MODEL	MODEL NUMBER			
	6-2-2 Basic Model	4-4-2 Basic Model	Trim Color	Paint Color
 <p><b>Panel Feed</b></p> <ul style="list-style-type: none"> <li>Includes base feed harness that connects to the electrical system in an adjacent PowerWorks Panel system. All required connection hardware included.</li> <li>Available in two 10-wire styles: 6-2-2 (6 circuits) and 4-4-2 (4 circuits). Note: 10-wire styles must match on all electrical parts.</li> </ul>	VOLET6PF6L	VOLET4PF6L	<input type="checkbox"/>	<input type="checkbox"/>
	VOLET6PF6R	VOLET4PF6R	<input type="checkbox"/>	<input type="checkbox"/>
 <p><b>Receptacles*</b></p> <ul style="list-style-type: none"> <li>Includes the modular duplex 15 amp receptacle that snaps onto a rigid wireway</li> <li>Available in two 10-wire styles: 6-2-2 (6 circuits) and 4-4-2 (4 circuits). Note: 10-wire styles must match on all electrical parts.</li> </ul>	VOLET6RC1	VOLET4RC1	<input type="checkbox"/>	<input type="checkbox"/>
	VOLET6RC2	VOLET4RC2	<input type="checkbox"/>	<input type="checkbox"/>
	VOLET6RC3		<input type="checkbox"/>	<input type="checkbox"/>
	VOLET6RC4I	VOLET4RC3I		
	VOLET6RC5I	VOLET4RC4I		
	VOLET6RC6I			
 <p><b>Power Pass Through</b></p> <ul style="list-style-type: none"> <li>Includes the power pass through harness that allows power to continue through one side of a desk between two rigid wireway equipped desks</li> <li>Available in two 10-wire styles: 6-2-2 (6 circuits) and 4-4-2 (4 circuits). Note: 10-wire styles must match on all electrical parts.</li> <li>Length must match the desk length it is passing through</li> </ul>	VOLET6PP24	VOLET4PP24		
	VOLET6PP30	VOLET4PP30		
	VOLET6PP36	VOLET4PP36		
	VOLET6PP42	VOLET4PP42		
	VOLET6PP48	VOLET4PP48		
	VOLET6PP54	VOLET4PP54		
	VOLET6PP60	VOLET4PP60		
	VOLET6PP66	VOLET4PP66		
VOLET6PP72	VOLET4PP72			
 <p><b>Stanchion Power Tap</b></p> <ul style="list-style-type: none"> <li>Provides a duplex 15 amp receptacle that is located behind a desk stanchion door</li> <li>Circuit number will be determined by the receptacle it is plugged into</li> <li>Two lengths available: 36" used when it is plugged into a rigid wireway receptacle 96" used when it is plugged into an adjacent building wall receptacle</li> </ul>	VOLESR36	VOLESR36		
	VOLESR96	VOLESR96		
<p><b>Leg Cover for Base Feed</b></p> <ul style="list-style-type: none"> <li>Provides a steel leg cover with a hole to allow the base feed harness to enter the leg below the desk</li> </ul>	VOLLCBI	VOLLCBI	<input type="checkbox"/>	<input type="checkbox"/>

A

A

B

C

### HOW TO ORDER

Indicate the following information on order form:

- Quantity of each item.
- Model Number, including options.  
See "How to Build a Model Number".
- Any special service required.

- Note:
- The  indicates that a choice is required.
  - The absence of the  indicates that no choice is required.
  - Alpha-numeric characters in place of  indicate that no other options are available.

### HOW TO BUILD A MODEL NUMBER

- A** Select basic model.
- B** Select trim color (if required).\*\*
- BL** = Black
- GR** = Grey
- LG** = Light Tone
- SA** = Sand
- WG** = Warm Grey
- \*\*Trim color matches paint color.
- C** Select paint color (if required).
- See pages 6-9 for color addendum.

\*Receptacles on circuits 3I, 4I, 5I, and 6I are always orange.

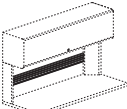
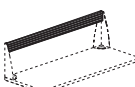
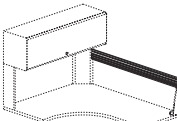
	MODEL	Width	MODEL NUMBER		
			Basic Model	Paint Color	
 <p><b>Between Stanchion Mounted Tool Rail Kit</b></p> <ul style="list-style-type: none"> <li>• Mounts above the worksurface off the stanchions used to support any overhead storage unit</li> <li>• Allows paper management accessories to be hung off the tool rail</li> <li>• Includes the aluminum tool rail and all required mounting hardware</li> <li>• "Width" refers to the desk size the tool rail is mounted above (not the distance between stanchions)</li> </ul>		<b>24"</b>	VOLTSM24	<input type="checkbox"/>	<input type="checkbox"/>
		<b>30"</b>	VOLTSM30	<input type="checkbox"/>	<input type="checkbox"/>
		<b>36"</b>	VOLTSM36	<input type="checkbox"/>	<input type="checkbox"/>
		<b>42"</b>	VOLTSM42	<input type="checkbox"/>	<input type="checkbox"/>
		<b>48"</b>	VOLTSM48	<input type="checkbox"/>	<input type="checkbox"/>
		<b>54"</b>	VOLTSM54	<input type="checkbox"/>	<input type="checkbox"/>
		<b>60"</b>	VOLTSM60	<input type="checkbox"/>	<input type="checkbox"/>
		<b>66"</b>	VOLTSM66	<input type="checkbox"/>	<input type="checkbox"/>
	<b>72"</b>	VOLTSM72	<input type="checkbox"/>	<input type="checkbox"/>	
 <p><b>Worksurface Mounted Tool Rail Kit</b></p> <ul style="list-style-type: none"> <li>• Mounts above the worksurface on brackets that attach to the grommets at each back corner</li> <li>• Allows paper management accessories to be hung off the tool rail</li> <li>• Includes the aluminum tool rail and all required mounting hardware</li> <li>• "Width" refers to the desk size the tool rail is mounted above (tool rail size must match desk size)</li> </ul>		<b>24"</b>	VOLTWM24	<input type="checkbox"/>	<input type="checkbox"/>
		<b>30"</b>	VOLTWM30	<input type="checkbox"/>	<input type="checkbox"/>
		<b>36"</b>	VOLTWM36	<input type="checkbox"/>	<input type="checkbox"/>
		<b>42"</b>	VOLTWM42	<input type="checkbox"/>	<input type="checkbox"/>
		<b>48"</b>	VOLTWM48	<input type="checkbox"/>	<input type="checkbox"/>
		<b>54"</b>	VOLTWM54	<input type="checkbox"/>	<input type="checkbox"/>
		<b>60"</b>	VOLTWM60	<input type="checkbox"/>	<input type="checkbox"/>
		<b>66"</b>	VOLTWM66	<input type="checkbox"/>	<input type="checkbox"/>
	<b>72"</b>	VOLTWM72	<input type="checkbox"/>	<input type="checkbox"/>	
 <p><b>Stanchion &amp; On-Worksurface Mounted Tool Rail Kit</b></p> <ul style="list-style-type: none"> <li>• Mounts above the worksurface between a stanchion used to support any overhead storage unit and an end mount bracket</li> <li>• Allows paper management accessories to be hung off the tool rail</li> <li>• Includes the aluminum tool rail and all required mounting hardware</li> <li>• "Width" refers to the desk size the tool rail is mounted above (tool rail size must match desk size)</li> </ul>		<b>24"</b>	VOLTSO24	<input type="checkbox"/>	<input type="checkbox"/>
		<b>30"</b>	VOLTSO30	<input type="checkbox"/>	<input type="checkbox"/>
		<b>36"</b>	VOLTSO36	<input type="checkbox"/>	<input type="checkbox"/>
		<b>42"</b>	VOLTSO42	<input type="checkbox"/>	<input type="checkbox"/>
		<b>48"</b>	VOLTSO48	<input type="checkbox"/>	<input type="checkbox"/>
		<b>54"</b>	VOLTSO54	<input type="checkbox"/>	<input type="checkbox"/>
		<b>60"</b>	VOLTSO60	<input type="checkbox"/>	<input type="checkbox"/>
		<b>66"</b>	VOLTSO66	<input type="checkbox"/>	<input type="checkbox"/>
	<b>72"</b>	VOLTSO72	<input type="checkbox"/>	<input type="checkbox"/>	

A

B

**HOW TO ORDER**

Indicate the following information on order form:

1. Quantity of each item.
2. Model Number, including options. See "How to Build a Model Number".
3. Any special service required.







- Note:
- The  indicates that a choice is required.
  - The absence of the  indicates that no choice is required.
  - Alpha-numeric characters in place of  indicate that no other options are available.

**HOW TO BUILD A MODEL NUMBER**

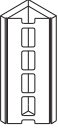
- A** Select size of basic model.
- B** Select paint color.  
See pages 6-9 for color addendum.

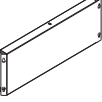
# Volition Components

## Volition Accessories

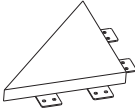
MODEL	MODEL NUMBER			
	Basic Model	Trim Color	Paint Color	Laminate Color
 <p><b>Freestanding Stanchion Large</b></p> <ul style="list-style-type: none"> <li>• 19½" tall (4 openings)</li> <li>• Stanchion door and top cap included</li> </ul>	VOLFSL	<input type="checkbox"/> <input type="checkbox"/>	<input type="checkbox"/> <input type="checkbox"/>	
 <p><b>Freestanding Stanchion Short</b></p> <ul style="list-style-type: none"> <li>• 11½" tall (2 openings)</li> <li>• Stanchion door and top cap included</li> </ul>	VOLFSS	<input type="checkbox"/> <input type="checkbox"/>	<input type="checkbox"/> <input type="checkbox"/>	
 <p><b>End Panel Trough</b></p> <ul style="list-style-type: none"> <li>• For 24" desk and attachment bolt</li> <li>• For 30" desk and attachment bolt</li> </ul>	VOLEPT24 VOLEPT30		<input type="checkbox"/> <input type="checkbox"/> <input type="checkbox"/> <input type="checkbox"/>	
 <p>Leg Grommet Cover</p>	Standard Leg Grommet (always black)	55020	BL	
 <p>Worksurface Grommet</p>	Leg Grommet Cover	55022	<input type="checkbox"/> <input type="checkbox"/>	
 <p>Worksurface Grommet Cover</p>	Worksurface Grommet	55023	<input type="checkbox"/> <input type="checkbox"/>	
	Worksurface Grommet Cover	55024	<input type="checkbox"/> <input type="checkbox"/>	
<p><b>Panel Mount Bracket</b></p> <ul style="list-style-type: none"> <li>• Allows a desk unit to be attached to a PowerWorks Panel</li> <li>• Black only</li> </ul>		VOLPMB.L VOLPMB.R	BL BL	
 <p><b>Worksurface Wedge</b></p> <ul style="list-style-type: none"> <li>• Mounts to two worksurfaces in an L configuration</li> <li>• Allows for keyboards to be used in corner conditions</li> <li>• Includes 4 splice plates and 16 screws</li> </ul>		WBVR12123L	<input type="checkbox"/> <input type="checkbox"/>	<input type="checkbox"/> <input type="checkbox"/> <input type="checkbox"/>
			<b>A</b>	<b>B</b>
			<b>C</b>	<b>D</b>

### HOW TO ORDER

Indicate the following information on order form:

1. Quantity of each item.
2. Model Number, including options.  
See "How to Build a Model Number".
3. Any special service required.

Note:

- The  indicates that a choice is required.
- The absence of the  indicates that no choice is required.
- Alpha-numeric characters in place of  indicate that no other options are available.

### HOW TO BUILD A MODEL NUMBER

- A** Select basic model. \_\_\_\_\_
- B** Select trim color.\* \_\_\_\_\_  
**BL** = Black  
**GR** = Grey  
**LG** = Light Tone  
**SA** = Sand  
**WG** = Warm Grey  
 \*Trim color matches paint color.
- C** Select paint color (if required). \_\_\_\_\_  
 See pages 6-9 for color addendum.
- D** Select laminate (if required). \_\_\_\_\_  
 See pages 6-9 for color addendum.

Specifications are subject to change without prior notice.

